

HECHT[®]

made for garden

Your reliable partner
in the garden
for more than
30 years

2025
catalogue



2 000000 003740

ACCESSORIES, EXTENSION CORDS

Welcome to the New Hecht Catalog 2025,

we are thrilled to present our latest range of top-quality garden equipment, combining modern technology, precision craftsmanship, and reliability you can count on.

Our products are not just tools—they are the key to unlocking the full potential of your garden or workspace. In this catalog, you will find a wide variety of innovative solutions, including brand-new models designed to meet our customers' needs and bring efficiency and comfort to your tasks.

Explore our new products in the garden tractor segment, featuring the models **Hecht 5286**, **Hecht 5386**, and the highly intriguing **Hecht 5107**. For easy handling, you'll appreciate the **accu wheelbarrow Hecht 2623**. We are also expanding our **accu programs**, and for tree maintenance, we recommend the practical set **Hecht 99126**.

As electromobility continues to show great potential, we are introducing new models such as the **petrol bikes Hecht 51125**, **Hecht 51126**, and the quad bikes **Hecht 56110** and **Hecht 56130**.

The long-standing popularity of our brand is built on three core principles: **reliability**, **performance**, and **partnership**. Whether you're a professional gardener, a distributor, or a gardening enthusiast, we believe you'll find products that make your work easier and ensure excellent results.

Take a moment to browse through this catalog and discover everything our brand has to offer.

Thank you for your trust, and we look forward to continuing our partnership!

You can learn more about our products online on: <https://en.hecht.cz/>
Contact HECHT export sales team by mail: export@hecht.cz

HECHT 50437

MOWER WITH SOUND - TOY



MADE IN ITALY



With sound while moving



6 PCS

weight 0,9 kg dimensions 50 × 27,5 × 52 cm

120153

EXTENSION CORD



| | | |
|--|-------------------------|-------------------------|
| | cable length | 20 m |
| | electric | 230 V/50 Hz |
| | 3 × 1,5 mm ² | Ingress Protection IP20 |

130153

EXTENSION CORD



| | | |
|--|-------------------------|-------------------------|
| | cable length | 30 m |
| | electric | 230 V/50 Hz |
| | 3 × 1,5 mm ² | Ingress Protection IP20 |

121153

CABLE REEL



| | | |
|--|-------------------------|-------------------------|
| | cable length | 20 m |
| | electric | 230 V/50 Hz |
| | 3 × 1,5 mm ² | Ingress Protection IP20 |

420153

CABLE REEL WITH 4 SOCKETS



| | | |
|--|-------------------------|-------------------------|
| | cable length | 20 m |
| | electric | 230 V/50 Hz |
| | 3 × 1,5 mm ² | Ingress Protection IP20 |

150153

CABLE REEL



| | | |
|--|-------------------------|-------------------------|
| | cable length | 50 m |
| | electric | 230 V/50 Hz |
| | 3 × 1,5 mm ² | Ingress Protection IP20 |

450153

CABLE REEL WITH 4 SOCKETS



| | | |
|--|-------------------------|-------------------------|
| | cable length | 50 m |
| | electric | 230 V/50 Hz |
| | 3 × 1,5 mm ² | Ingress Protection IP20 |



The product meets strict standards for children's toys (EN 71-1, EN 71-2, EN 71-3, 2009/48/EC).

CYLINDER AND ELECTRIC LAWN MOWERS

HECHT 5030

CYLINDER LAWN MOWER



Contact knife cylinder

Blade thickness 2 mm



| | | | |
|---------------|--------|-------------------|---------------|
| pushed | | height adjustment | 10–36 mm |
| working width | 30 cm | chassis | steel contact |
| weight | 7,8 kg | collecting box | 15 l |
| | | blade thickness | 2 mm |

HECHT 504

CYLINDER LAWN MOWER



Contact knife cylinder

Blade thickness 2 mm



| | | | |
|---------------|--------|-------------------|---------------|
| pushed | | height adjustment | 17–43 mm |
| working width | 40 cm | chassis | steel contact |
| weight | 8,8 kg | collecting box | 15 l |
| | | blade thickness | 2 mm |

HECHT 514 PROFI

CYLINDER LAWN MOWER



Contactless knife cylinder

Blade thickness 3 mm



| | | | |
|---------------|---------|-------------------|-------------------|
| pushed | | height adjustment | 24–75 mm |
| working width | 46 cm | chassis | steel contactless |
| weight | 17,2 kg | collecting box | 50 l |
| | | blade thickness | 3 mm |

HECHT 1233

ELECTRIC LAWN MOWER



Powerful high torque electric motor "TURBO motor"



| | | | |
|---------------|-------------|---------------------|----------|
| pushed | | height adjustment | 20–60 mm |
| electric | 230 V/50 Hz | chassis | plastic |
| power input | 1200 W | weight | 7,1 kg |
| working width | 33 cm | collecting box | 30 l |
| | | wheels (front/rear) | 5,5/5,5" |

HECHT 1434

ELECTRIC LAWN MOWER



Powerful high torque electric motor "TURBO motor"



| | | | |
|--------------------------------------|-------------|---------------------|----------|
| pushed | | height adjustment | 25–65 mm |
| electric | 230 V/50 Hz | chassis | plastic |
| power input | 1400 W | weight | 12 kg |
| working width | 34 cm | collecting box | 35 l |
| central adjustment of cutting height | | wheels (front/rear) | 5,5/6" |

HECHT 1638 R

ELECTRIC LAWN MOWER



Powerful high torque electric motor "TURBO motor"



| | | | |
|--------------------------------------|-------------|---------------------|----------|
| pushed | | height adjustment | 25–65 mm |
| electric | 230 V/50 Hz | chassis | plastic |
| power input | 1600 W | weight | 13 kg |
| working width | 38 cm | collecting box | 45 l |
| central adjustment of cutting height | | wheels (front/rear) | 5,5/7" |

ELECTRIC LAWN MOWERS



HECHT 1844 ELECTRIC LAWN MOWER



Powerful high torque electric motor "TURBO motor"



HECHT 2044 ELECTRIC LAWN MOWER



model 2025
NEW

Powerful high torque electric motor "TURBO motor"

| | | | | |
|--|---------------|-------------|-------------------|--------------------------------------|
| | pushed | | height adjustment | 25–85 mm |
| | electric | 230 V/50 Hz | | chassis plastic |
| | power input | 1800 W | | collecting box 50 l |
| | working width | 42 cm | | wheels (front/rear) 6/8" |
| | weight | 15,5 kg | | central adjustment of cutting height |

| | | | | |
|--|---------------|-------------|-------------------|--------------------------------------|
| | pushed | | height adjustment | 20–70 mm |
| | electric | 230 V/50 Hz | | chassis plastic |
| | power input | 2000 W | | collecting box 50 l |
| | working width | 43 cm | | wheels (front/rear) 6 / 9,5" |
| | weight | 13,4 kg | | central adjustment of cutting height |



HECHT 1640 ELECTRIC LAWN MOWER



Induction brushless motor



Patented wheel design



HECHT 1641 ELECTRIC LAWN MOWER



Powerful high torque electric motor "TURBO motor"

| | | | | |
|--|---------------|-------------|-------------------|--------------------------------------|
| | pushed | | height adjustment | 25-75 mm |
| | electric | 230 V/50 Hz | | chassis steel |
| | power input | 1600 W | | collecting box 45 l |
| | working width | 40 cm | | wheels (front/rear) 6/8" |
| | weight | 20 kg | | central adjustment of cutting height |

| | | | | |
|--|--------------------------------------|-------------|-------------------|--------------------------|
| | pushed | | height adjustment | 30–75 mm |
| | electric | 230 V/50 Hz | | chassis steel |
| | power input | 1600 W | | collecting box 50 l |
| | working width | 41 cm | | wheels (front/rear) 7/8" |
| | weight | 21,3 kg | | mulching kit included |
| | central adjustment of cutting height | | | |



Patented wheel design



HECHT 1845 ELECTRIC LAWN MOWER



Powerful high torque electric motor "TURBO motor"



HECHT 1802 S 5in1 ELECTRIC LAWN MOWER



Induction brushless motor

| | | | | |
|--|--------------------------------------|-------------|-------------------|---------------------------|
| | pushed | | height adjustment | 30–75 mm |
| | electric | 230 V/50 Hz | | chassis steel |
| | power input | 1800 W | | collecting box 60 l |
| | working width | 46 cm | | wheels (front/rear) 8/11" |
| | weight | 23,8 kg | | mulching kit included |
| | central adjustment of cutting height | | | |

| | | | | |
|--|--------------------------------------|-------------|--|--|
| | self propelled | 3,3 km/h | | height adjustment 25–75 mm |
| | electric | 230 V/50 Hz | | chassis steel |
| | power input | 1800 W | | collecting box 50 l |
| | working width | 46 cm | | wheels (front/rear) 7/10" |
| | weight | 27 kg | | alternative side ejection + mulching kit |
| | central adjustment of cutting height | | | |

ELECTRIC AND PETROL LAWN MOWERS



Patented wheel design

HECHT 1803 S 5 in 1

ELECTRIC LAWN MOWER



Powerful high torque electric motor "TURBO motor"



| | | | |
|--------------------------------------|-------------|--|----------|
| self propelled | 3,6 km/h | height adjustment | 30–75 mm |
| electric | 230 V/50 Hz | chassis | steel |
| power input | 1800 W | collecting box | 60 l |
| working width | 46 cm | wheels (front/rear) | 8/11" |
| weight | 26,4 kg | alternative side ejection + mulching kit | |
| central adjustment of cutting height | | | |



HECHT 5408 PETROL LAWN MOWER



NEW

| | | | |
|---------------|--------------------|---------------------|----------|
| pushed | | height adjustment | 25–65 mm |
| engine HECHT | OHV | max. torque | 3,6 Nm |
| displacement | 80 cm ³ | chassis | plastic |
| working width | 41 cm | collecting box | 45 l |
| weight | 17,5 kg | wheels (front/rear) | 6/6" |



Patented wheel design

HECHT 540 PETROL LAWN MOWER



| | | | |
|---------------|---------------------|---------------------|----------|
| pushed | | height adjustment | 25-75 mm |
| engine | OHV | max. torque | 6,8 Nm |
| displacement | 127 cm ³ | chassis | steel |
| working width | 40,6 cm | collecting box | 40 l |
| weight | 20 kg | wheels (front/rear) | 7/7" |



Patented wheel design

HECHT 543 PETROL LAWN MOWER



| | | | |
|--------------------------------------|---------------------|---------------------|----------|
| pushed | | height adjustment | 25-65 mm |
| engine HECHT | OHV | max. torque | 4,7 Nm |
| displacement | 139 cm ³ | chassis | steel |
| working width | 43 cm | collecting box | 45 l |
| weight | 20,5 kg | wheels (front/rear) | 7/10" |
| central adjustment of cutting height | | | |



HECHT 546 C PETROL LAWN MOWER



| | | | |
|--------------------------------------|---------------------|---------------------|----------|
| pushed | | height adjustment | 25-75 mm |
| engine | OHV | max. torque | 7,8 Nm |
| displacement | 144 cm ³ | chassis | steel |
| working width | 46 cm | collecting box | 60 l |
| weight | 29 kg | wheels (front/rear) | 7/8" |
| central adjustment of cutting height | | | |



Patented wheel design

HECHT 546 PETROL LAWN MOWER



| | | | |
|--------------------------------------|---------------------|---------------------|----------|
| pushed | | height adjustment | 25-75 mm |
| engine | OHV | max. torque | 7,8 Nm |
| displacement | 150 cm ³ | chassis | steel |
| working width | 46 cm | collecting box | 55 l |
| weight | 31 kg | wheels (front/rear) | 7/10" |
| central adjustment of cutting height | | | |

EXPLANATION: ball bearings in all wheels

PETROL LAWN MOWERS

HECHT 5511 C PETROL LAWN MOWER



Side ejection

NEW



| | | | |
|--------------------------------------|---------------------|---------------------|----------|
| pushed | | height adjustment | 25-75 mm |
| engine | OHV | max. torque | 6,5 Nm |
| displacement | 141 cm ³ | chassis | steel |
| working width | 51 cm | side ejection only | |
| weight | 20 kg | wheels (front/rear) | 7/10" |
| central adjustment of cutting height | | | |

HECHT 5511 PETROL LAWN MOWER



Side ejection



Patented wheel design



| | | | |
|--------------------------------------|---------------------|---------------------|----------|
| pushed | | height adjustment | 30-80 mm |
| engine | OHV | max. torque | 7,8 Nm |
| displacement | 144 cm ³ | chassis | steel |
| working width | 51 cm | side ejection only | |
| weight | 23 kg | wheels (front/rear) | 7/10" |
| central adjustment of cutting height | | | |

HECHT 5511 BS PETROL LAWN MOWER



Side ejection



| | | | |
|--------------------------------------|---------------------|---------------------|----------|
| pushed | | height adjustment | 30-80 mm |
| engine B&S | Series 450 E | max. torque | 5,9 Nm |
| displacement | 125 cm ³ | chassis | steel |
| working width | 51 cm | side ejection only | |
| weight | 23 kg | wheels (front/rear) | 7/10" |
| central adjustment of cutting height | | | |

HECHT 541 S PETROL LAWN MOWER



NEW



Patented wheels design



| | | | |
|--------------------------------------|----------------------|---------------------|----------|
| self propelled | | height adjustment | 25-75 mm |
| engine | OHV | max. torque | 4 Nm |
| displacement | 79,8 cm ³ | chassis | steel |
| working width | 41 cm | collecting box | 45 l |
| weight | 18,5 kg | wheels (front/rear) | 6/8" |
| central adjustment of cutting height | | | |

HECHT 541 SW PETROL LAWN MOWER



Patented wheels design



| | | | |
|--------------------------------------|---------------------|---------------------|----------|
| self propelled | 3,4 km/h | height adjustment | 25-75 mm |
| engine | OHV | max. torque | 6,8 Nm |
| displacement | 127 cm ³ | chassis | steel |
| working width | 40 cm | collecting box | 40 l |
| weight | 23,5 kg | wheels (front/rear) | 7/8" |
| central adjustment of cutting height | | | |

HECHT 543 SX PETROL LAWN MOWER



Patented wheel design



| | | | |
|--------------------------------------|---------------------|---------------------|----------|
| self propelled | 3,25 km/h | height adjustment | 25-65 mm |
| engine | OHV | max. torque | 7,2 Nm |
| displacement | 139 cm ³ | chassis | steel |
| working width | 42,5 cm | collecting box | 45 l |
| weight | 26 kg | wheels (front/rear) | 7/10" |
| central adjustment of cutting height | | | |

PETROL LAWN MOWERS



Patented wheels design



HECHT 543 SW 5 in 1

PETROL LAWN MOWER



Gearbox



| | | | |
|--------------------------------------|----------------------|--|----------|
| self propelled | 3,6 km/h | height adjustment | 25-75 mm |
| engine HECHT | OHV | max.torque | 5,1 Nm |
| displacement | 98,5 cm ³ | steel chassis | 5 in 1 |
| working width | 43 cm | collecting box | 50 l |
| weight | 30 kg | wheels (front/rear) | 8/11" |
| central adjustment of cutting height | | alternative side ejection + mulching kit | |



Patented wheels design



HECHT 543 SWE 5 in 1

PETROL LAWN MOWER



Gearbox



| | | | |
|--------------------------------------|----------------------|--|----------|
| self propelled | 3,6 km/h | height adjustment | 25-75 mm |
| engine HECHT | OHV | max.torque | 5,1 Nm |
| displacement | 98,5 cm ³ | steel chassis | 5 in 1 |
| working width | 43 cm | collecting box | 50 l |
| weight | 33,7 kg | wheels (front/rear) | 8/11" |
| central adjustment of cutting height | | alternative side ejection + mulching kit | |
| battery | 12 V DC, 4,5 Ah | | |



HECHT 546 SCW 5 in 1

PETROL LAWN MOWER



Patented wheel design



HECHT 546 SX 5 in 1

PETROL LAWN MOWER



| | | | |
|--------------------------------------|---------------------|---------------------|----------|
| self propelled | 3,2 km/h | height adjustment | 25-75 mm |
| engine | OHV | max.torque | 7,8 Nm |
| displacement | 144 cm ³ | chassis | steel |
| working width | 46 cm | collecting box | 60 l |
| weight | 31,5 kg | wheels (front/rear) | 7/8" |
| central adjustment of cutting height | | | |

| | | | |
|--------------------------------------|---------------------|---------------------|----------|
| self propelled | 3,5 km/h | height adjustment | 25-75 mm |
| engine | OHV | max.torque | 7,8 Nm |
| displacement | 150 cm ³ | chassis | steel |
| working width | 46 cm | collecting box | 55 l |
| weight | 32 kg | wheels (front/rear) | 7/10" |
| central adjustment of cutting height | | | |



Patented wheel design



HECHT 547 SXW 5 in 1

PETROL LAWN MOWER



Patented wheel design



HECHT 547 SWR 5 in 1

PETROL LAWN MOWER



Plastic grass catcher

| | | | |
|--------------------------------------|---------------------|--|----------|
| self propelled | 3,6 km/h | height adjustment | 25-75 mm |
| engine | OHV | max.torque | 7,8 Nm |
| displacement | 150 cm ³ | chassis | steel |
| working width | 46 cm | collecting box | 55 l |
| collecting box | 32 kg | wheels (front/rear) | 7/10" |
| central adjustment of cutting height | | alternative side ejection + mulching kit | |

| | | | |
|--------------------------------------|---------------------|--|----------|
| self propelled | 3,6 km/h | height adjustment | 25-75 mm |
| engine HECHT | OHV | max.torque | 7,8 Nm |
| displacement | 150 cm ³ | chassis | steel |
| working width | 46 cm | collecting box | 55 l |
| collecting box | 34,5 kg | wheels (front/rear) | 7/10" |
| central adjustment of cutting height | | alternative side ejection + mulching kit | |

EXPLANATION: ball bearings in all wheels

PETROL LAWN MOWERS



Patented wheel design



HECHT 547 SWE 5 in 1

PETROL LAWN MOWER



Patented wheels design



EDGE CUTTING
ability of mowing at fence or wall



HECHT 548 SW 5 in 1

PETROL LAWN MOWER



Gearbox



| | | | | | |
|--|--------------------------------------|---------------------|--|--|----------|
| | self propelled | 3,6 km/h | | height adjustment | 25–75 mm |
| | engine HECHT | OHV | | max.torque | 7,8 Nm |
| | displacement | 150 cm ³ | | chassis | steel |
| | working width | 46 cm | | collecting box | 55 l |
| | collecting box | 34,5 kg | | wheels (front/rear) | 7/10" |
| | central adjustment of cutting height | | | alternative side ejection + mulching kit | |
| | li-ion battery | 20 V DC, 2 Ah | | | |

| | | | | | |
|--|--------------------------------------|---------------------|--|--|--------------|
| | self propelled | 3,6 km/h | | height adjustment | 25–75 mm |
| | engine HECHT | OHV | | max.torque | 7 Nm |
| | displacement | 135 cm ³ | | chassis | steel 5 in 1 |
| | working width | 46 cm | | collecting box | 60 l |
| | weight | 35,6 kg | | wheels (front/rear) | 8/11" |
| | central adjustment of cutting height | | | alternative side ejection + mulching kit | |



Patented wheels design



EDGE CUTTING
ability of mowing at fence or wall



HECHT 5484 SX 5 in 1

PETROL LAWN MOWER



Gearbox



4 speed



EDGE CUTTING
ability of mowing at fence or wall



HECHT 548 SWE 5 in 1

PETROL LAWN MOWER



Gearbox



| | | | | | |
|--|--------------------------------------|---------------------|--|--|--------------|
| | self propelled | 3-4,5 km/h | | height adjustment | 25–75 mm |
| | engine HECHT | OHV | | max.torque | 7 Nm |
| | displacement | 135 cm ³ | | chassis | steel 5 in 1 |
| | working width | 46 cm | | collecting box | 60 l |
| | weight | 36,7 kg | | wheels (front/rear) | 8/11" |
| | central adjustment of cutting height | | | alternative side ejection + mulching kit | |

| | | | | | |
|--|--------------------------------------|---------------------|--|--|--------------|
| | self propelled | 3,6 km/h | | height adjustment | 25–75 mm |
| | engine HECHT | OHV | | max.torque | 7 Nm |
| | displacement | 135 cm ³ | | chassis | steel 5 in 1 |
| | working width | 46 cm | | collecting box | 60 l |
| | weight | 39 kg | | wheels (front/rear) | 8/11" |
| | central adjustment of cutting height | | | alternative side ejection + mulching kit | |
| | battery | 12 V DC, 4,5 Ah | | | |



EDGE CUTTING
ability of mowing at fence or wall



Patented wheels design



HECHT 5484 SXE 5 in 1

PETROL LAWN MOWER



4 speed



| | | | | | |
|--|--------------------------------------|---------------------|--|--|----------|
| | self propelled | 3-4,5 km/h | | height adjustment | 25–75 mm |
| | engine HECHT | OHV | | max.torque | 7 Nm |
| | displacement | 135 cm ³ | | steel chassis | 5 in 1 |
| | working width | 46 cm | | collecting box | 60 l |
| | weight | 39,6 kg | | wheels (front/rear) | 8/11" |
| | central adjustment of cutting height | | | alternative side ejection + mulching kit | |
| | battery | 12 V DC, 4,5 Ah | | | |



HECHT 551 SC PETROL LAWN MOWER



| | | | | | |
|--|--------------------------------------|---------------------|--|---------------------|----------|
| | self propelled | 3,4 km/h | | height adjustment | 25-75 mm |
| | engine | OHV | | max.torque | 7 Nm |
| | displacement | 161 cm ³ | | chassis | steel |
| | working width | 51 cm | | collecting box | 55 l |
| | weight | 27,5 kg | | wheels (front/rear) | 8/10" |
| | central adjustment of cutting height | | | | |

PETROL LAWN MOWERS



model 2025



HECHT 551 SX 5 in 1

PETROL LAWN MOWER



| | | | | | |
|--|--------------------------------------|---------------------|--|--|--------------|
| | self propelled | 3,2–3,6 km/h | | height adjustment | 25–75 mm |
| | engine HECHT | OHV | | max.torque | 9,4 Nm |
| | displacement | 175 cm ³ | | chassis | steel 5 in 1 |
| | working width | 51 cm | | collecting box | 70 l |
| | weight | 37 kg | | wheels (front/rear) | 8/10" |
| | central adjustment of cutting height | | | alternative side ejection + mulching kit | |



HECHT 550 SW 5 in 1

PETROL LAWN MOWER



Plastic grass catcher

| | | | | | |
|--|--------------------------------------|---------------------|--|--|--------------|
| | self propelled | 3,2 km/h | | height adjustment | 25-75 mm |
| | engine HECHT | OHV | | max.torque | 10 Nm |
| | displacement | 170 cm ³ | | chassis | steel 5 in 1 |
| | working width | 48 cm | | collecting box | 60 l |
| | weight | 35,5 kg | | wheels (front/rear) | 8/11,5" |
| | central adjustment of cutting height | | | alternative side ejection + mulching kit | |

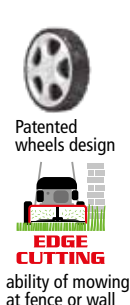

HECHT 553 SW 5 in 1

PETROL LAWN MOWER



Gearbox



| | | | | | |
|--|--------------------------------------|---------------------|--|--|--------------|
| | self propelled | 3,6 km/h | | height adjustment | 25–75 mm |
| | engine HECHT | OHV | | max.torque | 8,5 Nm |
| | displacement | 173 cm ³ | | chassis | steel 5 in 1 |
| | working width | 51 cm | | collecting box | 60 l |
| | weight | 38,1 kg | | wheels (front/rear) | 8/11" |
| | central adjustment of cutting height | | | alternative side ejection + mulching kit | |

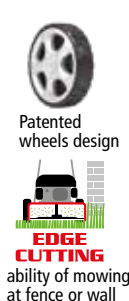

HECHT 551 SXE 5 in 1

PETROL LAWN MOWER



| | | | | | |
|--|--------------------------------------|---------------------|--|--|--------------|
| | self propelled | 3,6 km/h | | height adjustment | 25-75 mm |
| | engine HECHT | OHV | | max.torque | 11,2 Nm |
| | displacement | 200 cm ³ | | chassis | steel 5 in 1 |
| | working width | 51 cm | | collecting box | 65 l |
| | weight | 40 kg | | wheels (front/rear) | 8/10" |
| | central adjustment of cutting height | | | alternative side ejection + mulching kit | |

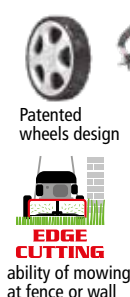

HECHT 5534 SX 5 in 1

PETROL LAWN MOWER



Gearbox



| | | | | | |
|--|--------------------------------------|---------------------|--|--|--------------|
| | self propelled | 3-4,5 km/h | | height adjustment | 25–75 mm |
| | engine HECHT | OHV | | max.torque | 10 Nm |
| | displacement | 173 cm ³ | | chassis | steel 5 in 1 |
| | working width | 51 cm | | collecting box | 60 l |
| | weight | 38,7 kg | | wheels (front/rear) | 8/11" |
| | central adjustment of cutting height | | | alternative side ejection + mulching kit | |



HECHT 5534 SWE 5 in 1

PETROL LAWN MOWER



| | | | | | |
|--|--------------------------------------|---------------------|--|--|--------------|
| | self propelled | 3-4,5 km/h | | height adjustment | 25–75 mm |
| | engine HECHT | OHV | | max.torque | 8,5 Nm |
| | displacement | 173 cm ³ | | chassis | steel 5 in 1 |
| | working width | 51 cm | | collecting box | 60 l |
| | weight | 42,3 kg | | wheels (front/rear) | 8/11" |
| | central adjustment of cutting height | | | alternative side ejection + mulching kit | |



battery 12 V DC, 4,5 Ah

PETROL LAWN MOWERS, ACCESSORIES



HECHT 551 BS 5 in 1

PETROL LAWN MOWER



Patented wheel design



EDGE CUTTING
ability of mowing at fence or wall



HECHT 554 SX 5 in 1

PETROL LAWN MOWER



| | | | | | |
|--|--|---------------------|--|---------------------|----------|
| | self propelled | | | height adjustment | 25–75 mm |
| | engine B&S | Series 750 EX | | max.torque | 9,5 Nm |
| | displacement | 161 cm ³ | | chassis | steel |
| | working width | 51 cm | | collecting box | 70 l |
| | alternative side ejection + mulching kit | | | wheels (front/rear) | 8/10" |
| | central adjustment of cutting height | | | | |

| | | | | | |
|--|--------------------------------------|---------------------|--|--|--------------|
| | self propelled | 3,6 km/h | | height adjustment | 25–75 mm |
| | engine HECHT | OHV | | max.torque | 12,2 Nm |
| | displacement | 224 cm ³ | | chassis | steel 5 in 1 |
| | working width | 53 cm | | collecting box | 75 l |
| | weight | 40 kg | | wheels (front/rear) | 8/10" |
| | central adjustment of cutting height | | | alternative side ejection + mulching kit | |



ability of mowing at fence or wall



Patented wheel design



HECHT 554 SXE 5 in 1

PETROL LAWN MOWER



Patented wheels design



EDGE CUTTING
ability of mowing at fence or wall



HECHT 5564 SX 5 in 1

PETROL LAWN MOWER



Gearbox



4 speed

| | | | | | |
|--|--------------------------------------|---------------------|--|--|--------------|
| | self propelled | 3,6 km/h | | height adjustment | 25–75 mm |
| | engine HECHT | OHV | | max.torque | 12,2 Nm |
| | displacement | 224 cm ³ | | chassis | steel 5 in 1 |
| | working width | 53 cm | | collecting box | 75 l |
| | weight | 41 kg | | wheels (front/rear) | 8/10" |
| | central adjustment of cutting height | | | alternative side ejection + mulching kit | |
| | li-ion battery | 20 V DC, 2 Ah | | | |

| | | | | | |
|--|--------------------------------------|---------------------|--|--|--------------|
| | self propelled | 3-4,5 km/h | | height adjustment | 25–75 mm |
| | engine Loncin | OHV | | max.torque | 10,5 Nm |
| | displacement | 196 cm ³ | | chassis | steel 5 in 1 |
| | working width | 56 cm | | collecting box | 70 l |
| | weight | 40,6 kg | | wheels (front/rear) | 8/11" |
| | central adjustment of cutting height | | | alternative side ejection + mulching kit | |

HECHT 500046

Special lawn mower „TURBO“ blade 46 cm for prod. year till 2019

For models:
HECHT 548 SW (from 2014), 5484 SX, 548 SWE, 5484 SXE



HECHT 500051

Special lawn mower „TURBO“ blade 51 cm for prod. year till 2019

For models:
HECHT 551 SB, 553 SW, 5534 SX, 5534 SWE, 5534 INSTANT

HECHT 502046

Special lawn mower „TURBO“ blade 46 cm for prod. year from 2020

For models:
HECHT 548 SW, 5483 SWE



HECHT 502051

Special lawn mower „TURBO“ blade 51 cm for prod. year from 2020

For models:
HECHT 5533 SW, 5543 SXE, 553 SW, 5534 SWE

HECHT 502056

Special lawn mower „TURBO“ blade 56 cm for prod. year from 2020

For models:
HECHT 5564 SX, 5564 SXE, 5563 SXE



Patented wheels HECHT

The brand new design of wheels HECHT improves traction on wet grass and helps with self-cleaning properties.



EDGE CUTTING
ability of mowing at fence or wall



Patented wheels design



HECHT 5564 SXE 5 in 1

PETROL LAWN MOWER



Gearbox



4 speed

| | | | | | |
|--|--------------------------------------|---------------------|--|--|--------------|
| | self propelled | 3-4,5 km/h | | height adjustment | 25–75 mm |
| | engine Loncin | OHV | | max.torque | 10,5 Nm |
| | displacement | 196 cm ³ | | chassis | steel 5 in 1 |
| | working width | 56 cm | | collecting box | 70 l |
| | weight | 45,2 kg | | wheels (front/rear) | 8/11" |
| | central adjustment of cutting height | | | alternative side ejection + mulching kit | |
| | battery | 12 V DC, 7 Ah | | | |

PETROL LAWN MOWERS



Patented wheels design



HECHT 5433 SW 5 in 1 PETROL LAWN MOWER



360° rotating front wheel



| | | | |
|--------------------------------------|----------------------|--|--------------|
| self propelled | 3,3 km/h | height adjustment | 25-75 mm |
| engine HECHT | OHV | max.torque | 5,1 Nm |
| displacement | 98,5 cm ³ | chassis | steel 5 in 1 |
| working width | 43 cm | collecting box | 50 l |
| weight | 31 kg | wheels (front/rear) | 8/11" |
| central adjustment of cutting height | | alternative side ejection + mulching kit | |



Patented wheels design



HECHT 5483 SW 5 in 1 PETROL LAWN MOWER



360° rotating front wheel



| | | | |
|--------------------------------------|---------------------|--|--------------|
| self propelled | 3,3 km/h | height adjustment | 25-75 mm |
| engine HECHT | OHV | max.torque | 7 Nm |
| displacement | 135 cm ³ | chassis | steel 5 in 1 |
| working width | 46 cm | collecting box | 60 l |
| weight | 36,1 kg | wheels (front/rear) | 8/11" |
| central adjustment of cutting height | | alternative side ejection + mulching kit | |



Patented wheels design



HECHT 5483 SWE 5 in 1 PETROL LAWN MOWER



360° rotating front wheel



Electric starter



EASY ELECTRIC START - JUST PRESS THE BUTTON.

| | | | |
|--------------------------------------|---------------------|--|--------------|
| self propelled | 3,3 km/h | height adjustment | 25-75 mm |
| engine HECHT | OHV | max.torque | 7 Nm |
| displacement | 135 cm ³ | chassis | steel 5 in 1 |
| working width | 46 cm | collecting box | 60 l |
| weight | 41,1 kg | wheels (front/rear) | 8/11" |
| central adjustment of cutting height | | alternative side ejection + mulching kit | |
| battery | 12 V DC, 4,5 Ah | | |



Patented wheels design



HECHT 5533 SW 5 in 1 PETROL LAWN MOWER



360° rotating front wheel



| | | | |
|--------------------------------------|---------------------|--|--------------|
| self propelled | 3,3 km/h | height adjustment | 25-75 mm |
| engine HECHT | OHV | max.torque | 10 Nm |
| displacement | 173 cm ³ | chassis | steel 5 in 1 |
| working width | 51 cm | collecting box | 60 l |
| weight | 39,2 kg | wheels (front/rear) | 8/11" |
| central adjustment of cutting height | | alternative side ejection + mulching kit | |



Patented wheels design



HECHT 5543 SXE 5 in 1 PETROL LAWN MOWER



360° rotating front wheel



EASY ELECTRIC START - JUST PRESS THE BUTTON.

| | | | |
|--------------------------------------|---------------------|--|--------------|
| self propelled | 3-4,5 km/h | height adjustment | 25-75 mm |
| engine HECHT | OHV | max.torque | 10 Nm |
| displacement | 173 cm ³ | chassis | steel 5 in 1 |
| working width | 51 | collecting box | 60 l |
| weight | 43,5 kg | wheels (front/rear) | 8/11" |
| central adjustment of cutting height | | alternative side ejection + mulching kit | |
| battery | 12 V DC, 4,5 Ah | | |



Patented wheels design



HECHT 5563 SXE 5 in 1 PETROL LAWN MOWER



360° rotating front wheel



| | | | |
|--------------------------------------|---------------------|--|--------------|
| self propelled | 3-4,5 km/h | height adjustment | 25-75 mm |
| engine HECHT | OHV | max.torque | 10 Nm |
| displacement | 173 cm ³ | chassis | steel 5 in 1 |
| working width | 56 cm | collecting box | 60 l |
| weight | 46 kg | wheels (front/rear) | 8/11" |
| central adjustment of cutting height | | alternative side ejection + mulching kit | |
| battery | 12 V DC, 7 Ah | | |

PETROL AND ROBOTIC LAWN MOWERS



HECHT 551 XR 5 in 1

PETROL LAWN MOWER



360° rotating front wheel



Wire 100 m,
20 AWG



HECHT 5604 ACCU ROBOTIC LAWN MOWER



Easy installation

3 knives

Front charge

Analogue control without app

AUTOMATIC

| | | | | | |
|--|--------------------------------------|---------------------|--|--|--------------|
| | self propelled | 3,5 km/h | | height adjustment | 25-75 mm |
| | engine HECHT | OHV | | max.torque | 10 Nm |
| | displacement | 209 cm ³ | | chassis | steel 5 in 1 |
| | working width | 51 cm | | collecting box | 75 l |
| | weight | 37,3 kg | | wheels (front/rear) | 7/11" |
| | central adjustment of cutting height | | | alternative side ejection + mulching kit | |

| | | | | | |
|--|---|--|--|--|-------------------------|
| | accu Li-Ion | DC 20 V | | chassis | plastic |
| | Accu | 2 Ah | | recommended area | max. 400 m ² |
| | working width | 160 mm | | nails for boundary wire included (106 pcs) | |
| | height adjustment | 25-45 mm | | charging base | |
| | wire: length / diameter / cross section | AWG 20: 100 m / 0,8118 mm / 0,5176 mm ² | | | |



Wire 100 m,
20 AWG

HECHT 5605 ACCU ROBOTIC LAWN MOWER



MOBILE APP

EN, D, DK, CZ, SK, PL, H, RUS, F, BG, FIN, NL, LT, RO, N, P, S, E, I



3 carbon brushless motors

3 knives

Front charge

Display



AUTOMATIC

| | | | | | |
|--|---|--|--|------------------|-------------------------|
| | accu Li-Ion | DC 20 V | | chassis | plastic |
| | Accu | 2 Ah | | recommended area | max. 500 m ² |
| | working width | 180 mm | | bluetooth app | |
| | height adjustment | 20-60 mm | | charging base | |
| | wire: length / diameter / cross section | AWG 20: 100 m / 0,8118 mm / 0,5176 mm ² | | | |



Wire 130 m,
20 AWG

HECHT 5608 ACCU ROBOTIC LAWN MOWER



MOBILE APP

EN, D, DK, CZ, SK, PL, H, RUS, F, BG, FIN, NL, LT, RO, N, P, S, E, I



3 carbon brushless motors

3 knives

Front charge

Display



AUTOMATIC

| | | | | | |
|--|---|--|--|------------------|-------------------------|
| | accu Li-Ion | DC 20 V | | chassis | plastic |
| | Accu | 2,5 Ah | | recommended area | max. 800 m ² |
| | working width | 180 mm | | bluetooth app | |
| | height adjustment | 20-60 mm | | charging base | |
| | wire: length / diameter / cross section | AWG 20: 130 m / 0,8118 mm / 0,5176 mm ² | | | |

Accessories

HECHT 005612

PROTECTIVE ROOF FOR MODELS HECHT 5605, 5608, 5612, 5615



HECHT 005615W

Boundary wire 100 m (18 AWG) - for HECHT 5615

HECHT005612W

Boundary wire 100 m (20 AWG) - for HECHT 5604, 5605, 5608, 5612



HECHT005612K

Knife and screw set (3+3 pcs) - for HECHT 5605, 5608, 5612, 5615



HECHT005612P

Demarcation pin (120 pcs) - for HECHT 5604, 5605, 5608, 5612, 5615



HECHT005612C

Connection connector (2 pcs) - for HECHT 5604, 5605, 5608, 5612, 5615



Wire 200 m,
20 AWG

HECHT 5612 ACCU ROBOTIC LAWN MOWER



MOBILE APP

EN, D, DK, CZ, SK, PL, H, RUS, F, BG, FIN, NL, LT, RO, N, P, S, E, I



3 carbon brushless motors

3 knives

Front charge

Display



AUTOMATIC

| | | | | | |
|--|---|--|--|------------------|--------------------------|
| | accu Li-Ion | DC 20 V | | chassis | plastic |
| | Accu | 5 Ah | | recommended area | max. 1200 m ² |
| | working width | 180 mm | | bluetooth app | |
| | height adjustment | 20-60 mm | | charging base | |
| | wire: length / diameter / cross section | AWG 20: 200 m / 0,8118 mm / 0,5176 mm ² | | | |

ROBOTIC AND ACCU LAWN MOWERS



Wire 220 m,
18 AWG

3 carbon
brushless
motors

3 knives

Front charge

Display



HECHT 5615 ACCU ROBOTIC LAWN MOWER



MOBILE APP
EN, D, DK, CZ, SK, PL, H, RUS, F,
BG, FIN, NL, LT, RO, N, P, S, E, I



AUTOMATIC

| | | | | | |
|--|---|--|--|------------------|--------------------------|
| | accu Li-Ion | DC 20 V | | chassis | plastic |
| | Accu | 5 Ah | | recommended area | max. 1500 m ² |
| | working width | 180 mm | | bluetooth app | |
| | height adjustment | 20-60 mm | | charging base | |
| | wire: length / diameter / cross section | AWG 18: 220 m / 1,0237 mm / 0,8230 mm ² | | | |



NEW

HECHT 5072 ACCU LAWN MOWER



Available
from 4/25

| | | | | | |
|--|----------------------------------|----------------------|-------------------|----------------|------------|
| | pushed | | height adjustment | 30-55 mm | |
| | accu Li-Ion | DC 20 V | | chassis | plastic |
| | Li-Ion | 1 × 2 / 4 / 6 / 8 Ah | | collecting box | 30 l |
| | working width | 32 cm | | charging time | ≤ 50 min. |
| | weight | 10,6 kg | | working time | ≤ 25 min.* |
| | wheels (front/rear) | 5,5/5,5" | | | |
| | battery and charger not included | | | | |



HECHT 5025 ACCU LAWN MOWER



| | | | | | |
|--|----------------------------------|------------|-------------------|--------------------------------------|-----------|
| | pushed | | height adjustment | 25-65 mm | |
| | accu Li-Ion | DC 20 V | | chassis | plastic |
| | Li-Ion | 2 × 2,5 Ah | | collecting box | 26 l |
| | working width | 32 cm | | central adjustment of cutting height | |
| | weight | 9,5 kg | | charging time | 120 min. |
| | wheels (front/rear) | 5,5/6" | | working time | ≤ 20 min. |
| | battery and charger not included | | | | |



HECHT 5034 ACCU LAWN MOWER



| | | | | | |
|--|----------------------------------|--------------------|-------------------|--------------------------------------|------------|
| | pushed | | height adjustment | 20-65 mm | |
| | accu Li-Ion | DC 40 V | | chassis | plastic |
| | Li-Ion | 1 × 2,5 / 4 / 5 Ah | | collecting box | 35 l |
| | working width | 34 cm | | central adjustment of cutting height | |
| | weight | 9,9 kg | | charging time | ≤ 150 min. |
| | wheels (front/rear) | 6/7" | | working time | ≤ 30 min. |
| | battery and charger not included | | | | |



HECHT 5038 ACCU LAWN MOWER



| | | | | | |
|--|----------------------------------|--------------------|-------------------|--------------------------------------|------------|
| | pushed | | height adjustment | 25-75 mm | |
| | accu Li-Ion | DC 40 V | | chassis | plastic |
| | Li-Ion | 1 × 2,5 / 4 / 5 Ah | | collecting box | 40 l |
| | working width | 38 cm | | central adjustment of cutting height | |
| | weight | 16,4 kg | | charging time | ≤ 150 min. |
| | wheels (front/rear) | 6/9" | | working time | ≤ 60 min. |
| | battery and charger not included | | | | |



HECHT 5070 ACCU LAWN MOWER



Mulching kit
included

| | | | | | |
|--|----------------------------------|----------------|-------------------|--------------------------------------|-----------|
| | pushed | | height adjustment | 30-80 mm | |
| | accu Li-Ion | DC 20+20 V | | chassis | plastic |
| | Li-Ion | 2 × 2/4/6/8 Ah | | collecting box | 40 l |
| | working width | 40 cm | | central adjustment of cutting height | |
| | weight | 16,5 kg | | charging time* | ≤ 50 min. |
| | wheels (front/rear) | 6/8" | | working time* | ≤ 25 min. |
| | battery and charger not included | | | | |

ACCU LAWN MOWERS



HECHT 5043 ACCU LAWN MOWER

★★★★★



Patented wheels design



HECHT 5041 ACCU LAWN MOWER

★★★★★



| | | | | |
|--|----------------------------------|--|--------------------------------------|------------|
| | pushed | | height adjustment | 25-75 mm |
| | accu Li-Ion DC 40 V | | chassis | plastic |
| | Li-Ion 1x 2,5 / 4 / 5 Ah | | collecting box | 50 l |
| | working width 43 cm | | central adjustment of cutting height | |
| | weight 14 kg | | charging time | ≤ 150 min. |
| | wheels (front/rear) 6/9" | | working time | ≤ 64 min. |
| | battery and charger not included | | | |

| | | | | |
|--|----------------------------------|--|--------------------------------------|------------|
| | pushed | | height adjustment | 25-75 mm |
| | accu Li-Ion DC 40 V | | chassis | steel |
| | Li-Ion 1x 2,5 / 4 / 5 Ah | | collecting box | 50 l |
| | working width 41 cm | | central adjustment of cutting height | |
| | weight 18,6 kg | | charging time | ≤ 150 min. |
| | battery and charger not included | | working time | ≤ 66 min. |
| | battery and charger not included | | mulching kit | ✓ |



Patented wheels design



HECHT 5041 S ACCU LAWN MOWER

★★★★★



Patented wheels design



ability of mowing at fence or wall



HECHT 5045 S ACCU LAWN MOWER

★★★★★



| | | | | |
|--|----------------------------------|--|--------------------------------------|------------|
| | self propelled 3,5 km/h | | height adjustment | 25-75 mm |
| | accu Li-Ion DC 40 V | | chassis | steel |
| | Li-Ion 1x 2,5 / 4 / 5 Ah | | collecting box | 50 l |
| | working width 41 cm | | central adjustment of cutting height | |
| | weight 21,3 kg | | charging time | ≤ 150 min. |
| | wheels (front/rear) 7/8" | | working time | ≤ 44 min. |
| | battery and charger not included | | mulching kit | ✓ |

| | | | | |
|--|----------------------------------|--|--|------------|
| | self propelled 3,5 km/h | | height adjustment | 25-75 mm |
| | accu Li-Ion DC 40 V | | chassis | steel |
| | Li-Ion 1x 2,5 / 4 / 5 Ah | | collecting box | 60 l |
| | working width 46 cm | | central adjustment of cutting height | |
| | weight 23,6 kg | | charging time | ≤ 150 min. |
| | wheels (front/rear) 7/8" | | working time | ≤ 40 min. |
| | battery and charger not included | | alternative side ejection + mulching kit | ✓ |



Patented wheels design



ability of mowing at fence or wall



HECHT 5051 S 5 in 1 ACCU LAWN MOWER

★★★★★



Patented wheels design



ability of mowing at fence or wall



HECHT 6246 S 5 in 1 ACCU LAWN MOWER



Replaces the petrol engine in terms of performance

| | | | | |
|--|----------------------------------|--|--|------------|
| | self propelled 3,3 km/h | | height adjustment | 25-75 mm |
| | accu Li-Ion DC 40 V | | chassis | steel |
| | Li-Ion 2x 2,5 / 4 / 5 Ah | | collecting box | 60 l |
| | working width 51 cm | | central adjustment of cutting height | |
| | weight 27,7 kg | | charging time | ≤ 150 min. |
| | wheels (front/rear) 8/11" | | working time | ≤ 64 min. |
| | battery and charger not included | | alternative side ejection + mulching kit | ✓ |

| | | | | |
|--|----------------------------------|--|--|-----------|
| | self-propelled | | height adjustment | 25-75 mm |
| | accu Li-Ion DC 62 V | | chassis | steel |
| | Li-Ion 1x 2,5 / 4 Ah | | collecting box | 60 l |
| | working width 46 cm | | central adjustment of cutting height | |
| | weight 32 kg | | charging time | ≤ 75 min. |
| | wheels (front/rear) 8/11" | | working time | ≤ 58 min. |
| | battery and charger not included | | alternative side ejection + mulching kit | ✓ |

ACCU AND PETROL LAWN MOWERS

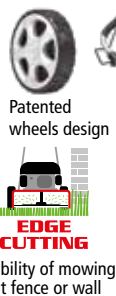

HECHT 6251 S 5 in 1 ACCU LAWN MOWER



| | | | | |
|--|----------------------------------|--|--|-----------|
| | self-propelled | | height adjustment | 25–75 mm |
| | accu Li-Ion | | chassis | steel |
| | Li-Ion | | collecting box | 60 l |
| | working width | | central adjustment of cutting height | |
| | weight | | charging time | ≤ 75 min. |
| | wheels (front/rear) | | working time | ≤ 50 min. |
| | battery and charger not included | | alternative side ejection + mulching kit | |



HECHT 587 SICKLE BAR MOWER



Cutting bar made of one piece

Laser cut blade

| | | | | |
|--|----------------|--|-------------------|----------|
| | self propelled | | height adjustment | 30-80 mm |
| | engine Loncin | | max.torque | 10,5 Nm |
| | displacement | | chassis | steel |
| | working width | | wheels | 13" |
| | weight | | | 59 kg |



HECHT 5060 MOTORIZED SELF-SEEDED WEED TRIMMER



SPEED 3 KM/H



MADE IN THE CZECH REPUBLIC

| | | | | |
|--|----------------|--|------------|-----------|
| | self propelled | | height | 35 mm |
| | engine HECHT | | max.torque | 10 Nm |
| | displacement | | chassis | steel |
| | working width | | wheels | 16x3,5-8" |
| | weight | | | 52 kg |



HECHT 5812 FLAIL MOWER



32x Y-shaped blades



| | | | | |
|--|--------------------------------------|--|--|----------|
| | self propelled | | height | 20-80 mm |
| | engine Loncin | | max.torque | 15,6 Nm |
| | displacement | | chassis | steel |
| | working width | | drive, 3 gears forward, 1 gear reverse | |
| | weight | | wheels | 8/13" |
| | central adjustment of cutting height | | | |

EXPLANATION: ball bearings in all wheels

LAWN TRACTORS



HECHT 5161

LAWN TRACTOR



**WORKING WIDTH
61 CM**



| | |
|--------------------------------------|--|
| self propelled | height adjustment 35–75 mm |
| engine HECHT OHV | max. torque 11,5 Nm |
| displacement 224 cm ³ | chassis steel |
| working width 61 cm | collecting box 150 l |
| weight 115 kg | fuel tank volume 2 l |
| central adjustment of cutting height | max. speed: forward / reverse 4,6 / 2,3 km/h |
| wheels Ø (front/rear) 10/13" | electric start, manual gearbox |



HECHT 5162

LAWN TRACTOR



Gearbox

PEERLESS GEAR

**WORKING WIDTH
62 CM**



| | |
|--------------------------------------|--|
| self propelled | height adjustment 30–90 mm |
| engine B&S Series 950 | max. torque 11,5 Nm |
| displacement 224 cm ³ | chassis steel |
| working width 62 cm | collecting box 130 l |
| weight 125 kg | fuel tank volume 1,8 l |
| central adjustment of cutting height | max. speed: forward / reverse 4,5 / 1,5 km/h |
| wheels Ø (front/rear) 11 / 13" | electric start, automatic gearbox |



HECHT 5114

LAWN TRACTOR



Gearbox

PEERLESS GEAR



**Side
ejection
only**

**WORKING WIDTH
98 CM**



| | |
|----------------------------------|--|
| self propelled | height adjustment 30–90 mm |
| engine Loncin OHV, 1 cylinder | chassis steel |
| displacement 432 cm ³ | fuel tank volume 7,5 l |
| engine power 12 HP | wheels Ø (front/rear) 15 / 18" |
| working width 98 cm | max. speed: forward/reverse 8,3 / 1,5 km/h |
| weight 165 kg | central adjustment of cutting height |
| automatic gearbox | electric start |



HECHT 5118

LAWN TRACTOR



**Side
ejection
only**

**WORKING WIDTH
107 CM**



| | |
|----------------------------------|--|
| self propelled | height adjustment 25–100 mm |
| engine Loncin OHV, 1 cylinder | chassis steel |
| displacement 546 cm ³ | fuel tank volume 5,7 l |
| engine power 13,6 HP | wheels Ø (front/rear) 15 / 20" |
| working width 107 cm | max. speed: forward/reverse 7,5 / 2,5 km/h |
| weight 194 kg | central adjustment of cutting height |
| automatic CVT gearbox | electric start |



HECHT 5169

LAWN TRACTOR



**WORKING WIDTH
69 CM**



| | |
|---|--|
| self propelled | height adjustment 35–75 mm |
| engine Loncin OHV, 1 cylinder | chassis steel |
| displacement 224 cm ³ 1 cylinder | collecting box 220 l |
| engine power 6,8 HP | fuel tank volume 1,4 l |
| working width 69 cm | wheels (front/rear) 13 / 15" |
| weight 173 kg | max. speed: forward/reverse 7,6 / 2,2 km/h |
| mechanical gearbox | electric start |

LAWN TRACTORS

HECHT 5184

LAWN TRACTOR



Powered By
Loncin

WORKING WIDTH
84 CM

NEW



| | | | |
|--------------------|-----------------------------------|--------------------------------|----------------|
| self propelled | | height adjustment | 35–75 mm |
| engine Loncin | OHV, 1 cylinder | chassis | steel |
| displacement | 352 cm ³ 1 cylinder | collecting box | 220 l |
| engine power | 7,2 HP | fuel tank volume | 5 l |
| working width | 84 cm | wheels (front/rear) | 13 / 15" |
| weight | 155 kg | max. speed: forward/reverse | 8,4 / 2,4 km/h |
| mechanical gearbox | | electric start | |

HECHT 5196

LAWN TRACTOR



Powered By
Loncin

WORKING WIDTH
96 CM

NEW



| | | | |
|--------------------|-----------------------------------|--------------------------------|----------------|
| self propelled | | height adjustment | 35–75 mm |
| engine Loncin | OHV, 1 cylinder | chassis | steel |
| displacement | 452 cm ³ 1 cylinder | collecting box | 220 l |
| engine power | 9,2 HP | fuel tank volume | 5 l |
| working width | 96 cm | wheels (front/rear) | 13 / 18" |
| weight | 170 kg | max. speed: forward/reverse | 8,6 / 2,5 km/h |
| mechanical gearbox | | electric start | |

HECHT 5286

LAWN TRACTOR



Powered By
Loncin

WORKING WIDTH
86 CM

NEW



| | | | |
|--------------------|-----------------------------------|--------------------------------|--------------|
| self propelled | | height adjustment | 30–90 mm |
| engine Loncin | OHV, 1 cylinder | chassis | steel |
| displacement | 352 cm ³ 1 cylinder | collecting box | 250 l |
| engine power | 7,2 HP | fuel tank volume | 6 l |
| working width | 86 cm | wheels (front/rear) | 15" / 18" |
| weight | 180 kg | max. speed: forward/reverse | 8,9 / 4 km/h |
| mechanical gearbox | | electric start | |

LAWN TRACTORS

HECHT 5386

LAWN TRACTOR



Powered By
Loncin

NEW

**WORKING WIDTH
86 CM**



| | | | | | |
|--|-----------------------|-----------------------------------|-------------------|--------------------------------|--------------|
| | self propelled | | height adjustment | 30–90 mm | |
| | engine Loncin | OHV, 1 cylinder | | chassis | steel |
| | displacement | 432 cm ³ 1 cylinder | | collecting box | 250 l |
| | engine power | 11,9 HP | | fuel tank volume | 6 l |
| | working width | 86 cm | | wheels (front/rear) | 15" / 18" |
| | weight | 188 kg | | max. speed: forward/reverse | 8,9 / 4 km/h |
| | automatic CVT gearbox | | electric start | | |

HECHT 5192

LAWN TRACTOR



Powered By
Loncin

Gearbox



**HECHT 005192
MULCHING KIT**

**HECHT 005103
TRAILER HITCH KIT**

**WORKING WIDTH
92 CM**



| | | | | | |
|--|-------------------------------|-----------------------------------|-------------------|--------------------------------|-------------------|
| | hydrostatic self propelled | | height adjustment | 30–90 mm | |
| | engine Loncin | OHV, 1 cylinder | | chassis | steel |
| | displacement | 452 cm ³ 1 cylinder | | collecting box | 245 l |
| | engine power | 12,5 HP | | fuel tank volume | 7,5 l |
| | working width | 92 cm | | wheels (front/rear) | 15/18" |
| | weight | 167 kg | | max. speed: forward/reverse | 8,8 / 4,5 km/h |
| | hydrostatic clutch HYDRO-GEAR | | electric start | | |

HECHT 5198

LAWN TRACTOR



Powered By
Loncin



NEW

**WORKING WIDTH
98 CM**



| | | | | | |
|--|----------------------------|-----------------------------------|-------------------|--------------------------------|--------------|
| | hydrostatic self propelled | | height adjustment | 30–90 mm | |
| | engine Loncin | OHV, 1 cylinder | | chassis | steel |
| | displacement | 452 cm ³ 1 cylinder | | collecting box | 250 l |
| | engine power | 12,5 HP | | fuel tank volume | 6 l |
| | working width | 98 cm | | wheels (front/rear) | 15" / 18" |
| | weight | 200 kg | | max. speed: forward/reverse | 8,9 / 4 km/h |
| | automatic CVT gearbox | | electric start | | |

HECHT 5176 LAWN TRACTOR



INTEK™

Gearbox



**WORKING WIDTH
102 CM**



108 cm

260 cm

108 cm

| | | | | |
|--|---|--|-----------------------------|----------------|
| | hydrostatic self propelled | | height adjustment | 30–90 mm |
| | engine B&S INTEK 31R7 Series 4 | | chassis | steel |
| | displacement 500 cm ³ 1 cylinder | | collecting box | 270 l |
| | engine power 13,3 HP | | fuel tank volume | 7,5 l |
| | working width 102 cm | | wheels (front/rear) | 15/18" |
| | weight 220 kg | | max. speed: forward/reverse | 8,8 / 3,8 km/h |
| | hydrostatic clutch HYDRO-GEAR | | electric start | |



Suitable for mowing large areas and football fields.

HECHT 5102 TWIN LAWN TRACTOR



Gearbox



**HECHT 005102
MULCHING KIT**

**HECHT 005103
TRAILER HITCH KIT**

2 CYLINDERS

WORKING WIDTH 102 CM



111 cm

231 cm

96 cm

| | | | | |
|--|--|--|-----------------------------|----------------|
| | hydrostatic self propelled | | height adjustment | 30–90 mm |
| | engine Loncin OHV, 2 cylinders | | chassis | steel |
| | displacement 586 cm ³ 2 cylinders | | collecting box | 245 l |
| | engine power 17 HP | | fuel tank volume | 7,5 l |
| | working width 102 cm | | wheels (front/rear) | 15/18" |
| | weight 197 kg | | max. speed: forward/reverse | 8,8 / 4,5 km/h |
| | hydrostatic clutch HYDRO-GEAR | | electric start | |



Suitable for mowing large areas and football fields.

HECHT 5227 LAWN TRACTOR



Gearbox



BRIGGS & STRATTON
PROFESSIONAL

2 CYLINDERS

WORKING WIDTH 102 CM



108 cm

260 cm

108 cm

| | | | | |
|--|--|--|-----------------------------|--------------|
| | hydrostatic self propelled | | height adjustment | 30–90 mm |
| | engine B&S 44U8 Professional series | | chassis | steel |
| | displacement 724 cm ³ 2 cylinders | | collecting box | 270 l |
| | engine power 20,5 HP | | fuel tank volume | 7,5 l |
| | working width 102 cm | | wheels (front/rear) | 15/18" |
| | weight 230 kg | | max. speed: forward/reverse | 8,8/3,8 km/h |
| | Hydro-Gear gearbox | | electric start | |



LAWN TRACTORS, SPREADER, TRAILER

Suitable for mowing large areas and football fields.



HECHT 5927 LAWN TRACTOR



Gearbox



2 CYLINDERS

WORKING WIDTH 112 CM



| | | | | |
|--|--|--|-----------------------------|--------------|
| | hydrostatic self propelled | | height adjustment | 30–90 mm |
| | engine B&S 44U8 Professional series | | chassis | steel |
| | displacement 724 cm ³ 2 cylinders | | collecting box | 270 l |
| | engine power 20,5 HP | | fuel tank volume | 7,5 l |
| | working width 112 cm | | wheels (front/rear) | 15/18" |
| | weight 235 kg | | max. speed: forward/reverse | 8,8/3,8 km/h |
| | hydrostatic clutch HYDRO-GEAR | | electric start | |

HECHT 5107 ZERO TURN LAWN TRACTOR



Gearbox



NEW

WORKING WIDTH 107 CM



| | | | | |
|--|---|--|-----------------------------|------------|
| | hydrostatic self propelled | | height adjustment | 25–102 mm |
| | engine Loncin | | chassis | steel |
| | displacement 546 cm ³ 1 cylinder | | collecting box | 250 l |
| | engine power 15 HP | | fuel tank volume | 11,4 l |
| | working width 107 mm | | wheels (front/rear) | 11" / 20" |
| | weight 234 kg | | max. speed: forward/reverse | 9 / 4 km/h |
| | hydrostatic clutch HYDRO-GEAR | | electric start | |

www.hecht.cz



Suitable for: HECHT 5114, HECHT 5116, HECHT 5184, HECHT 5196, HECHT 5286, HECHT 5386, HECHT 5186, HECHT 5192, HECHT 5198, HECHT 5176, HECHT 5102, HECHT 5227, HECHT 5727, HECHT 5927 and most garden tractors

HECHT 260 SPREADING CART

Tow-behind spreader for large areas of ground



Spreading regulation

**Bin cover included
Tested with corn grains**

| | | | | |
|--|----------------|--|-------------------------|------|
| | pulled | | max capacity | 60 l |
| | weight 12,6 kg | | max. width of spreading | 4 m* |
| | wheels 12x3" | | | |

HECHT 50006 FOLDING WAGON FOR LEISURE ACTIVITIES

FOLDING WAGON FOR LEISURE ACTIVITIES



Easy folding

2x seatbelts for kids transportation

Front brakes

Polyester fabric, steel powder coated frame

| | | | | |
|--|------------------------------------|--|--------------------------|-----------|
| | dimensions L 123 x W 56 x H 102 cm | | wheels diameter / height | 5 / 20 cm |
| | weight 15 kg | | max. load | 80 kg |

TRAILERS, ACCU WHEELBARROWS

GARDEN

Suitable for: HECHT 5114, HECHT 5116, HECHT 5184, HECHT 5196, HECHT 5286, HECHT 5386, HECHT 5186, HECHT 5192, HECHT 5198, HECHT 5176, HECHT 5102, HECHT 5227, HECHT 5727, HECHT 5927 and most garden tractors

HECHT 52150 GARDEN CART

75 L
TILTING



Possible to use as trailer for lawn tractor

NEW



| | | | | | |
|--|-----------------|-------------------------|--|-----------|--------------|
| | body dimensions | 101 x 57 x 22 cm / 85 l | | wheels | 10" * 3.50-4 |
| | weight | 14,7 kg | | max. load | 150 kg |

Suitable for: HECHT 5114, HECHT 5116, HECHT 5184, HECHT 5196, HECHT 5286, HECHT 5386, HECHT 5186, HECHT 5192, HECHT 5198, HECHT 5176, HECHT 5102, HECHT 5227, HECHT 5727, HECHT 5927 and most garden tractors

HECHT 52184 GARDEN CART

180 L



Possible to use as trailer for lawn tractor



| | | | | | |
|--|-----------------|---------------------------|--|-----------|-------------|
| | body dimensions | 97 x 51,5 x 42 cm / 180 l | | wheels | 10" x 350-4 |
| | weight | 23 kg | | max. load | 250 kg |

Suitable for: HECHT 5114, HECHT 5116, HECHT 5184, HECHT 5196, HECHT 5286, HECHT 5386, HECHT 5186, HECHT 5192, HECHT 5198, HECHT 5176, HECHT 5102, HECHT 5227, HECHT 5727, HECHT 5927 and most garden tractors

HECHT 53350 GARDEN CART

290 L



Possible to use as trailer for lawn tractor



| | | | | | |
|--|-----------------|------------------|--|-----------|--------------|
| | body dimensions | 118 x 57 x 32 cm | | wheels | 13" x 5.00-6 |
| | weight | 27 kg | | max. load | 350 kg |

HECHT 0053080

Towing connection for HECHT 53080



HECHT 53080 TRAILER

Suitable for: HECHT 5114, HECHT 5116, HECHT 5184, HECHT 5196, HECHT 5286, HECHT 5386, HECHT 5186, HECHT 5192, HECHT 5198, HECHT 5176, HECHT 5102, HECHT 5227, HECHT 5727, HECHT 5927 and most garden tractors

200 L **94 cm** **122 cm** **TILTING**

Transport wheel



| | | | | | |
|--|-----------------|----------------------|--|-----------|-----------|
| | body dimensions | 150 x 93,5 x 74,5 cm | | wheels | 480/400-8 |
| | weight | 37,3 kg | | max. load | 300 kg |

HECHT 2620 ACCU WHEELBARROW



ECO FRIENDLY

| | | | | | |
|--|----------------|---------|--------------|------------------|--------|
| | self-propelled | | max capacity | 80 l | |
| | accu | 24 V | | max speed | 6 km/h |
| | power input | 280 W | | weight | 40 kg |
| | wheel | 5.00-8" | | charging time | 7 h |
| | max load | 260 kg | | max working time | 10 h |

HECHT 2623 ACCU WHEELBARROW



NEW

HECHT 002623 optional



ECO FRIENDLY

| | | | | | |
|--|----------------|---------|--------------|------------------|--------|
| | self-propelled | | max capacity | 100 l | |
| | accu | 24 V | | max speed | 6 km/h |
| | power input | 280 W | | weight | 50 kg |
| | wheel | 5.00-8" | | charging time | 7 h |
| | max load | 260 kg | | max working time | 7 h |

* The spreading width depends mainly on the speed / movement and the type of spreading material.

SERVICE KIT, OILS, LUBRICANTS, ACCESSORIES



HECHT 4T
RECOMMENDED OIL FOR 4-STROKE ENGINES
 Volume 0,8 l
 Min. order 12 pcs



HECHT 2T 450
RECOMMENDED OIL FOR 2-STROKE ENGINES
 Volume 0,45 l
 Min. order 12 pcs



HECHT CHAINOIL 4L
SPECIAL OIL FOR GREASING BARS 4 L
 Min. order 3 pcs



HECHT 5W-40
RECOMMENDED OIL FOR 4-STROKE ENGINES
 - suitable for all year use
 Volume 0,8 l
 Min. order 12 pcs



HECHT CHAINOIL
SPECIAL OIL FOR GREASING BARS
 Volume 0,8 l
 Min. order 12 pcs



HECHT HC22
SPECIAL HYDRAULIC OIL 4 L
 Min. order 3 pcs



HECHT 5011
SERVICE KIT FOR PUMPING OUT GAS AND MOTOR OIL

Suitable for all types of 4-stroke lawn mowers and tractors.

HECHT 90001
UNIVERSAL MIXING BOTTLE



- 1:25 - 20 ml
- 1:50 - 10 ml
- 1:25 - 40 ml
- 1:50 - 20 ml
- 500 ml
- 1 L

PLASTIC CAN 5 l

No. K00050



»Made in Slovakia«



litres tank volume 5 l

PLASTIC CAN 20 l

No. K00200



»Made in Slovakia«



litres tank volume 20 l

PLASTIC CAN 10 l

No. K00100



»Made in Slovakia«



litres tank volume 10 l

PLASTIC CAN KOMBI

No. K00085



»Made in Slovakia«



litres tank volume 6 l + 2,5 l

www.hecht.cz



litres volume 1 l

litres tank volume 1 l

GREASE GX 100 ml

PLASTIC LUBRICANT for angle drives, min. order 10 pcs



MADE IN CZECH REPUBLIC

HECHT DW-410

LUBRICATING AND PRESERVATIVE OIL IN SPRAY
 12 pcs in package
 Volume 400 ml



MADE IN CZECH REPUBLIC



HECHT TRANSMISSION

SPECIAL GEAR OIL 80W-90
 Volume 0,8 l



MADE IN CZECH REPUBLIC



All canisters are approved for transport and storage of fuel.

ELECTRIC AND ACCU LAWN AERATORS

HECHT 1420 2 in 1 ELECTRIC LAWN AERATOR

☆☆☆☆☆
Powerful high torque electric motor "TURBO motor"



| | | | | | |
|----|---------------------|-------------|----|-------------------------|--------------------|
| ⚡ | electric | 230 V/50 Hz | 🗑️ | collecting box | 35 l |
| 🔌 | power input | 1500 W | 🛠️ | chassis | plastic |
| 📏 | working width | 32 cm * | 🎯 | roller with metal wires | |
| ⚖️ | weight | 9,2 kg | 📏 | variable adjustment | -12 to 4 mm |
| 🔪 | 16 metal knives | | 📏 | recommended area | 800 m ² |
| 🛞 | wheels (front/rear) | 7/4" | | | |

HECHT 1683 2 in 1 ELECTRIC LAWN AERATOR

☆☆☆☆☆
Powerful high torque electric motor "TURBO motor"



| | | | | | |
|----|---------------------|-------------|----|-------------------------|---------------------|
| ⚡ | electric | 230 V/50 Hz | 🗑️ | collecting box | 48 l |
| 🔌 | power input | 1600 W | 🛠️ | chassis | plastic |
| 📏 | working width | 36 cm * | 🎯 | roller with metal wires | |
| ⚖️ | weight | 11,6 kg | 📏 | variable adjustment | -12 to 6 mm |
| 🔪 | 16 metal knives | | 📏 | recommended area | 1000 m ² |
| 🛞 | wheels (front/rear) | 8/6" | | | |

HECHT 1848 2 in 1 ELECTRIC LAWN AERATOR

☆☆☆☆☆
Powerful high torque electric motor "TURBO motor"



| | | | | | |
|----|---------------------|-------------|----|-------------------------|---------------------|
| ⚡ | electric | 230 V/50 Hz | 🗑️ | collecting box | 55 l |
| 🔌 | power input | 1800 W | 🛠️ | chassis | plastic |
| 📏 | working width | 40 cm * | 🎯 | roller with metal wires | |
| ⚖️ | weight | 13 kg | 📏 | variable adjustment | -13 to 9 mm |
| 🔪 | 20 metal knives | | 📏 | recommended area | 1200 m ² |
| 🛞 | wheels (front/rear) | 7/5,5" | | | |

HECHT 1999 2 in 1 ELECTRIC LAWN AERATOR

☆☆☆☆☆
Powerful high torque electric motor "TURBO motor"



| | | | | | |
|----|---------------------|-------------|----|-------------------------|---------------------|
| ⚡ | electric | 230 V/50 Hz | 🗑️ | collecting box | 45 l |
| 🔌 | power input | 2000 W | 🛠️ | chassis | plastic |
| 📏 | working width | 38 cm * | 🎯 | roller with metal wires | |
| ⚖️ | weight | 14,5 kg | 📏 | variable adjustment | -10 to 5 mm |
| 🔪 | 16 metal knives | | 📏 | recommended area | 1300 m ² |
| 🛞 | wheels (front/rear) | 7/6" | | | |

HECHT 1739 ELECTRIC LAWN AERATOR

☆☆☆☆☆



| | | | | | |
|----|-----------------|-------------|----|---------------------|---------------------|
| ⚡ | electric | 230 V/50 Hz | 🗑️ | collecting box | 50 l |
| 🔌 | power input | 1700 W | 🛠️ | chassis | steel |
| 📏 | working width | 37 cm | 📏 | variable adjustment | -8 to 12 mm |
| ⚖️ | weight | 22 kg | 📏 | recommended area | 1200 m ² |
| 🔪 | 26 metal knives | | 🛞 | wheels (front/rear) | 8/8" |

HECHT 1384 ACCU LAWN AERATOR

☆☆☆☆☆







| | | | | | |
|----|----------------------------------|----------------------|----|---------------------|-------------|
| ⚡ | accu Li-Ion | DC 40 V / 2,5/4/5 Ah | 🗑️ | collecting box | 45 l |
| 📏 | working width | 38 cm * | 🛠️ | chassis | plastic |
| ⚖️ | weight | 14,5 kg | 📏 | variable adjustment | -10 to 5 mm |
| 🔪 | 16 metal knives | | 📏 | working time | 48 min |
| 🚫 | battery and charger not included | | | | |

* The working width can be different when using another aeration roller.

PETROL LAWN AERATORS, ROLLER, RAMPS

HECHT 5645 2 in 1

PETROL LAWN
AERATOR



NEW

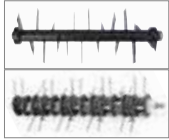

| | | | | | |
|--|------------------------------|---------------------|--|----------------------------------|-------|
| | engine | HECHT | | chassis | steel |
| | displacement | 210 cm ³ | | roller with metal wires | |
| | max. torque | 12 Nm | | variable adjustment -15 to 15 mm | |
| | scarifier drum cutting width | 40 cm* | | 15 metal knives | |
| | weight | 35 kg | | wheels (front/rear) | 8/8" |
| | collecting box | 50 l | | | |

HECHT 501 LAWN ROLLER



50 cm

| | | | | | |
|--|---------------|-------|--|---------------|-------------|
| | working width | 50 cm | | empty weight | 9 kg |
| | diameter | 32 cm | | filled weight | 50 kg ± 20% |

HECHT 5676 2 in 1

PETROL LAWN
AERATOR



NEW

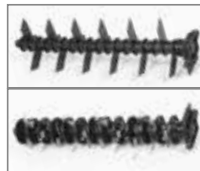

| | | | | | |
|--|------------------------------|---------------------|--|----------------------------------|-------|
| | engine | BS CR 950 | | chassis | steel |
| | displacement | 208 cm ³ | | roller with metal wires | |
| | max. torque | 12,9 Nm | | variable adjustment -15 to +5 mm | |
| | scarifier drum cutting width | 40 cm | | 18 metal knives | |
| | weight | 37 kg | | wheels (front/rear) | 8/8" |
| | collecting box | 45 l | | | |

HECHT 005003 LOADING RAMP

Galvanized sheet
1,5 mm

Unfoldable

2 pcs in package

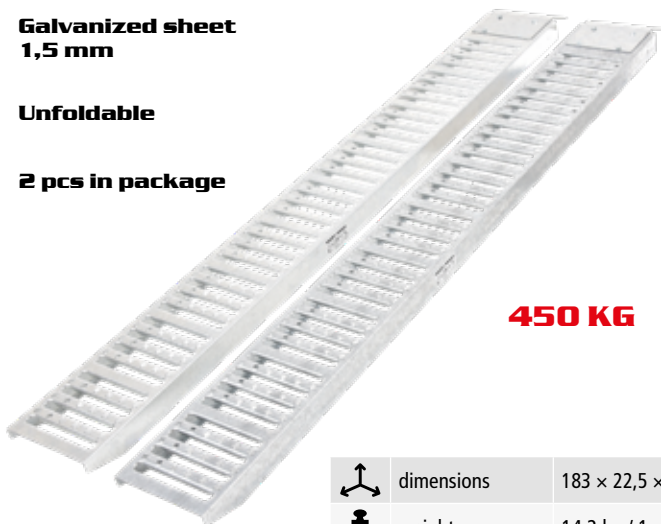

450 KG

| | | |
|--|---------------|-------------------|
| | dimensions | 183 × 22,5 × 5 cm |
| | weight | 14,2 kg / 1 pc |
| | load capacity | 450 kg |

HECHT 005005 LOADING RAMP

2 PCS IN PACKAGE

With
supports

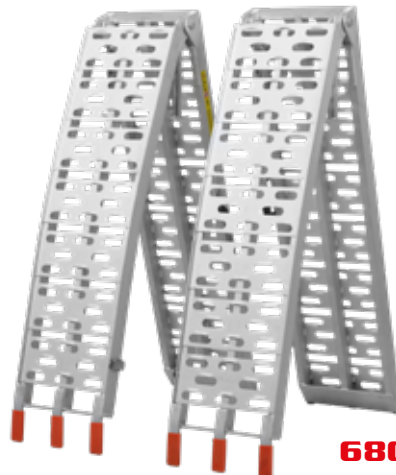

680 KG

FOLDABLE



| | | |
|--|---------------------------|-----------------|
| | dimensions | 225 × 28 × 5 cm |
| | weight | 7 kg / 1 pc |
| | load capacity - pc / pair | 340 kg / 680 kg |

ACCU, ELECTRIC AND PETROL TILLERS



Battery and charger not included



HECHT 7025
ACCU TILLER



| | | | | | |
|--|----------------------------------|---------------------|--|---------------|--------|
| | Accu Li-ion | DC 20 V / 1x 2,5 Ah | | working width | 20 cm |
| | battery and charger not included | | | weight | 3,4 kg |
| | 4x4 knives Ø 15 cm | | | 1 speed | |



HECHT 732
ELECTRIC TILLER



| | | | | | |
|--|--------------------|-------------|--|---------------|-------|
| | electric | 230 V/50 Hz | | working width | 32 cm |
| | power input | 750 W | | weight | 8 kg |
| | 4x4 knives Ø 20 cm | | | 1 speed | |



HECHT 738
ELECTRIC TILLER



| | | | | | |
|--|--------------------|-------------|--|---------------|---------|
| | electric | 230 V/50 Hz | | working width | 36,5 cm |
| | power input | 1000 W | | weight | 8,4 kg |
| | 4x4 knives Ø 20 cm | | | 1 speed | |



HECHT 745
ELECTRIC TILLER



| | | | | | |
|--|----------------------|-------------|--|---------------|-------|
| | electric | 230 V/50 Hz | | working width | 40 cm |
| | power input | 1500 W | | weight | 11 kg |
| | 6x4 knives Ø 20,5 cm | | | 1 speed | |



HECHT 752
PETROL TILLER



| | | | | | |
|--|--------------|--------------------|--|--------------------|---------|
| | engine HECHT | 2-stroke | | working width | 25 cm |
| | displacement | 52 cm ³ | | weight | 14,3 kg |
| | max.torque | 2,2 Nm | | 4x4 knives Ø 23 cm | |



HECHT 761
PETROL TILLER



1 SPEED

| | | | | | |
|--|--------------|---------------------|--|--------------------|-------|
| | engine HECHT | OHV, 4-stroke | | working width | 40 cm |
| | displacement | 150 cm ³ | | weight | 34 kg |
| | max.torque | 7,5 Nm | | 4x4 knives Ø 26 cm | |

PETROL TILLERS, ACCESSORIES

HECHT 746 PETROL TILLER



1 SPEED

| | | | | | |
|--|--------------|---------------------|--|--------------------|-------|
| | engine HECHT | OHV, 4-stroke | | working width | 60 cm |
| | displacement | 150 cm ³ | | weight | 32 kg |
| | max.torque | 7,5 Nm | | 6x4 knives Ø 26 cm | |

HECHT 785 PETROL TILLER



1 SPEED

| | | | | | |
|--|--------------|---------------------|--|------------------------|-------------|
| | engine | OHV, 4-stroke | | working width | 32/50/84 cm |
| | displacement | 212 cm ³ | | weight | 52 kg |
| | max.torque | 10,5 Nm | | 2/4/6x4 knives Ø 38 cm | |

HECHT 790 BS PETROL TILLER



Adjustable handle

Engine
Briggs&Stratton



1 SPEED

| | | | | | |
|--|--------------|---------------------|--|------------------------|-------------|
| | engine B&S | CR 950 | | working width | 32/50/84 cm |
| | displacement | 196 cm ³ | | weight | 55 kg |
| | max.torque | 12,9 Nm | | 2/4/6x4 knives Ø 38 cm | |

HECHT 750 PETROL TILLER



1 SPEED

| | | | | | |
|--|--------------|---------------------|--|--------------------|-------|
| | engine HECHT | OHV, 4-stroke | | working width | 50 cm |
| | displacement | 196 cm ³ | | weight | 70 kg |
| | max.torque | 12,4 Nm | | 4x3 knives Ø 34 cm | |

HECHT 000751 RIDGER



HECHT 000750 IRON WHEEL SET 14" - 2 pcs. for use with ridger



www.hecht.cz

ACCESSORIES FOR HECHT 785, HECHT 790 BS

HECHT 8001022

BRACKET
for mounting
accessories

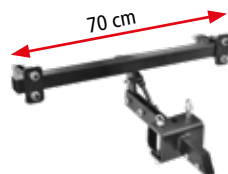

HECHT 8001020

POTATO
DIGGER

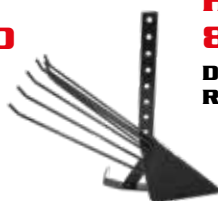

HECHT 8001015

DOUBLE SIDE
RIDGE PLOUGH



HECHT 8001016

SINGLE SIDE
RIDGE PLOUGH



HECHT 8001002

REAR BRACKET
for mounting
accessories



HECHT 8001018

WHEEL WEIGHTS
2x10 kg



HECHT 8001005

SNOW
PLOW



HECHT 8001021

SET OF DISTANCE TUBES
(2 pcs) for shaft extension
outer edge of wheels
65 - 85 cm



HECHT 8001017

WHEEL 4.00-8"
- 2 pcs



HECHT 8001004

IRON WHEEL SET
- 14"
- 2 pcs
- for use with
plough
or digger



PETROL TILLERS, ACCESSORIES

HECHT 000797

IRON WHEEL SET 15"

- 2 pcs for use with plough or digger



| Speed km/h | Gears | |
|----------------------------------|-----------|-----------|
| | 2 forward | 1 forward |
| Speed on axis (rpm) | 113 | 82 |
| 4.00-8" Wheels with tires (km/h) | 8,8 | 6,4 |

| | | | |
|---------------------------------|---------------------|--------------------|-------|
| engine HECHT | OHV, 4-stroke | working width | 80 cm |
| displacement | 212 cm ³ | weight | 68 kg |
| max.torque | 12 Nm | 6x4 knives Ø 31 cm | |
| 2 gears forward, 1 gear reverse | | | |

HECHT 796 PETROL TILLER



HECHT 000796

WHEELS 4.00-8"

WITH SLIPPING PINIONS



Hecht 796 + Hecht 000796
+ Hecht 57970 (Hecht 57100) + Hecht 57101

ACCESSORIES FOR HECHT 7100 / 796 / 7970

HECHT 007116 SINGLE SIDE PLOUGH

Intended for
HECHT 7100, 796



HECHT 007115 POTATO DIGGER

Intended for HECHT 7100,
7970 and 796

HECHT 007120 POTATO DIGGER

Intended for
HECHT 7100,
7970 and 796

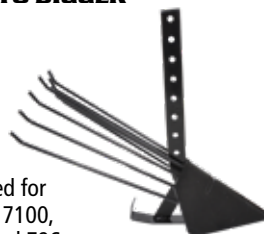

HECHT 007125 DOUBLE SIDE PLOUGH

20-25 cm, working depth ca 10 cm

Intended for
HECHT 7100,
7970 and 796



HECHT 007129

BRACKET
for mounting
accessories

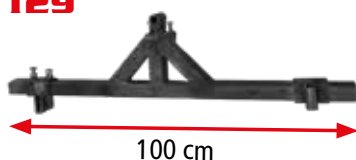

HECHT 007132

DITCHER
Working width 60 cm
Working depth ca 10 cm

Intended for HECHT 7100,
7970 and 796



PETROL TILLER, ACCESSORIES

HECHT 7970

PETROL TILLER



| | | | | | |
|--|--------------------|---------------------|--|--------------------|--------|
| | engine HECHT | OHV | | working width | 110 cm |
| | displacement | 212 cm ³ | | 8x3 knives Ø 34 cm | |
| | max.torque | 12 Nm | | weight | 78 kg |
| | 2 speed, 1 reverse | | | | |

Gearbox



HECHT 000721 PLOUGH



HECHT 000720 WHEELS 4.00-8" with slipping pinions



HECHT 000722 IRON WHEEL SET 15" - 2 pcs - for use with plough or digger

IRON WHEEL SET 15" - 2 pcs - for use with plough or digger



Hecht 7970 + Hecht 000720
+ Hecht 57970 (Hecht 57100) + Hecht 57101

HECHT 57970

TRAILER FOR HECHT 7100, 7970, 796

PLASTIC BED BODY

TILTING



| | | |
|--|--------------------|---|
| | overall dimensions | 259 x 116 x 79 cm |
| | weight | 52 kg |
| | wheels | 4 x 8" |
| | max. load | 300 kg net. / 375 kg including operator |
| | brakes | drum |

YouTube



HECHT 7100

PETROL TILLER



Gearbox



| | | | | | |
|--|----------------------------|---------------------|--|--------------------|--------|
| | engine HECHT | OHV, 4-stroke | | working width | 104 cm |
| | displacement | 212 cm ³ | | weight | 72 kg |
| | max. torque | 12 Nm | | 6x4 knives Ø 34 cm | |
| | 3 speed forward, 1 reverse | | | | |

HECHT 007104

IRON WHEEL SET 14"
- 2 pcs, for use with
plough or digger



| Speed km/h | | Gears | | | |
|------------------|---------------------------------|--------|--------|--------|------------------|
| | | Gear 3 | Gear 2 | Gear 1 | Gear -1 backward |
| Gearbox Standard | Speed on axis (rpm) | 130 | 98.9 | 33.5 | 33.5 |
| | 5.0-12 Wheels with tires (km/h) | 13.65 | 10.38 | 3.52 | 3.52 |

HECHT 007112

WHEEL 5.00-12" WITH
SLIPPING PINION - 2 pcs
- for use with trailer only
(not designed
for digging etc.)



Slipping pinion on
wheels for better
turning

Compatible with model from
production year 2020



HECHT 007101

WEIGHTS FOR WHEELS
2 pcs (2 x 12 kg)

Compatible
with HECHT
007112
and HECHT
007104



HECHT 7100 + Hecht 57100 (Hecht 57970)
+ Hecht 57101 + Hecht 007112

HECHT 57101

DRAWBAR



(Compatible
with trailers HECHT 57100, 57970
and tillers HECHT 7100, 7970, 796)

HECHT 57100

TRAILER FOR
HECHT 7100, 7970, 796

METAL BED BODY



| | | |
|--|------------|--|
| | dimensions | 130 x 92 x 34 cm |
| | weight | 105 kg |
| | wheels | 500 x 12" |
| | max. load | 400 kg net. / 475 kg including operator |
| | brakes | drum |

ELECTRIC AND ACCU HEDGE TRIMMERS

HECHT 603 ELECTRIC HEDGE TRIMMER



**LIGHT WEIGHT
1,9 kg**

| | | | | | |
|--|-----------------------|-------------|--|--------------------|--------|
| | electric | 230 V/50 Hz | | bar length | 50 cm |
| | power input | 550 W | | bar working length | 45 cm |
| | max. cutting diameter | 20 mm | | weight | 1,9 kg |

HECHT 655 ELECTRIC HEDGE TRIMMER



**LASER CUT
BLADE**



| | | | | | |
|--|-----------------------|-------------|--|--------------------|-------|
| | electric | 230 V/50 Hz | | bar length | 62 cm |
| | power input | 600 W | | bar working length | 55 cm |
| | max. cutting diameter | 20 mm | | weight | 3 kg |

HECHT 610 ELECTRIC HEDGE TRIMMER



Rotary handle



**LASER CUT
BLADE**

Available from 2/25

| | | | | | |
|--|-----------------------|-------------|--|--------------------|--------|
| | electric | 230 V/50 Hz | | bar length | 68 cm |
| | power input | 600 W | | bar working length | 61 cm |
| | max. cutting diameter | 24 mm | | weight | 3,1 kg |

HECHT 611 ELECTRIC HEDGE TRIMMER



Rotary handle

With collecting bar



**LASER CUT
BLADE**

| | | | | | |
|--|-----------------------|-------------|--|--------------------|-------|
| | electric | 230 V/50 Hz | | bar length | 68 cm |
| | power input | 750 W | | bar working length | 61 cm |
| | max. cutting diameter | 24 mm | | weight | 4 kg |

HECHT 6022 ACCU HEDGE TRIMMER

**ACCU
program
1278**

**Li-ion
Powered**



**LASER CUT
BLADE**

Rotary handle



**Battery
and charger
not included**

| | | | | | |
|--|-----------------------|--------------------------|--|--------------------|-------|
| | Accu Li-ion | DC 20V, 1x 2/4/6/8 Ah | | bar length | 58 cm |
| | max. cutting diameter | 15 mm | | bar working length | 51 cm |
| | no load working time | 65 min* | | weight | 3 kg |

HECHT 6020 ACCU HEDGE TRIMMER

**ACCU
program
6020**

**Li-ion
Powered**



**LASER CUT
BLADE**



| | | | | | |
|--|----------------------------------|------------------------|--|--------------------|-------|
| | Accu Li-ion | DC 20 V / 1x 2,5 Ah | | bar length | 61 cm |
| | max. cutting diameter | 15 mm | | bar working length | 45 cm |
| | battery and charger not included | | | weight | 2 kg |

ACCU AND PETROL HEDGE TRIMMERS

ACCU
program
6020

Rotary handle

HECHT 6225 ACCU HEDGE TRIMMER

★★★★★

2x 20 V

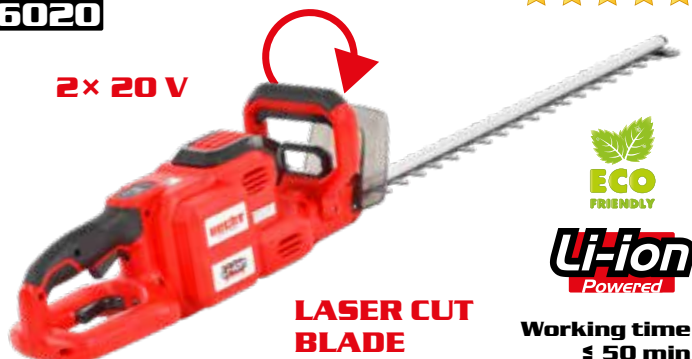

**LASER CUT
BLADE**

Working time
≤ 50 min



Li-ion
Powered

ACCU
program
5040

**LASER CUT
BLADE**

HECHT 6040 ACCU HEDGE TRIMMER

★★★★★



Working time
≤ 50 min



Li-ion
Powered

| | | | | | |
|--|----------------------------------|-----------|--|-----------------------|-------|
| | Accu Li-Ion | DC 20 V | | max. cutting diameter | 24 mm |
| | Li-Ion | 2x 2,5 Ah | | bar working length | 55 cm |
| | battery and charger not included | | | | |

| | | | | | |
|--|----------------------------------|----------------------------|--|--------------------|--------|
| | Accu Li-Ion | DC 40 V / 1x 2,5/4/5 Ah | | bar length | 76 cm |
| | max. cutting diameter | 20 mm | | bar working length | 55 cm |
| | battery and charger not included | | | weight | 4,3 kg |



HECHT 9245 PETROL HEDGE TRIMMER

★★★★★

Rotary handle



**LASER CUT
BLADE**

| | | | | | |
|--|-----------------------|----------------------|--|--------------------|--------|
| | engine volume | 25,4 cm ³ | | bar length | 70 cm |
| | power output | 1 HP | | bar working length | 60 cm |
| | max. cutting diameter | 22 mm | | weight | 5,4 kg |



HECHT 9275 PROFI PETROL HEDGE TRIMMER

★★★★★

Rotary handle



**LASER CUT
BLADE**

| | | | | | |
|--|-----------------------|----------------------|--|--------------------|--------|
| | engine volume | 22,2 cm ³ | | bar length | 75 cm |
| | power output | 1 HP | | bar working length | 69 cm |
| | max. cutting diameter | 28 mm | | weight | 5,4 kg |



**Collecting
bar**

HECHT 9375 PETROL HEDGE TRIMMER

★★★★★

PROFI TOOL



**LASER CUT
BLADE**

| | | | | | |
|--|-----------------------|----------------------|--|--------------------|--------|
| | engine volume | 22,2 cm ³ | | bar length | 72 cm |
| | power output | 0,9 HP | | bar working length | 67 cm |
| | max. cutting diameter | 20 mm | | weight | 5,3 kg |

DRILLING AUGER BITS

Diameter Part no.

100 mm 0052100

150 mm 0052150

200 mm 0052200

250 mm 0052250

EXTENSION TUBE

Diameter Part no.

400 mm 0052400



HECHT 52 EARTH AUGER

★★★★★



**DRILLING AUGER BIT
150 mm INCLUDED**

| | | | | | |
|--|--------------|----------|--|----------------|--------------------|
| | engine type | 2-stroke | | displacement | 52 cm ³ |
| | weight | 8,5 kg | | rotation speed | 260-310 rpm |
| | power output | 2,4 HP | | drilling depth | 730 mm |

ACCU AND ELECTRIC HEDGE TRIMMERS

ACCU program 6020



HECHT 6025

ACCU TELESCOPIC HEDGE TRIMMER



LASER CUT BLADE

Li-ion
Powered



| | | | | | |
|--|----------------------------------|-------------------|--|--------------------|---------|
| | accumulator | Lithium-ion | | bar length | 50 cm |
| | accu article (V) | DC 20 V / 1x 2 Ah | | bar working length | 45 cm |
| | max. cutting diameter | 15 mm | | weight | 3,5 kg |
| | battery and charger not included | | | machine length | 2–2,5 m |

HECHT 695

ELECTRIC HEDGE TRIMMER



LASER CUT BLADE

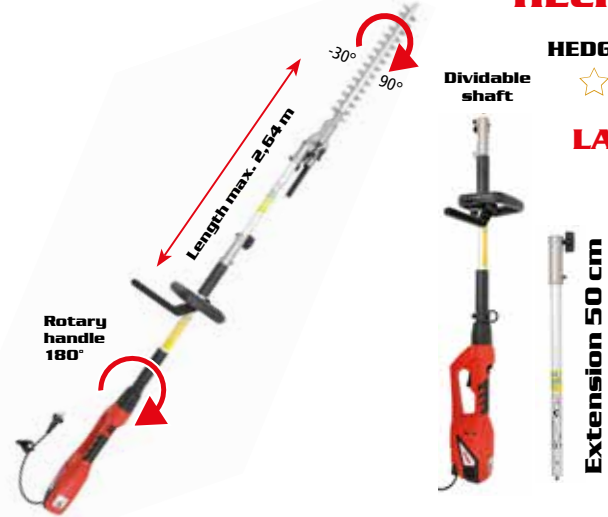

| | | | | | |
|--|-----------------------|-------------|--|----------------|--------|
| | electric | 230 V/50 Hz | | bar length | 41 cm |
| | power input | 900 W | | weight | 4,9 kg |
| | max. cutting diameter | 20 mm | | machine length | 2,64 m |

HECHT 675

ELECTRIC TELESCOPIC HEDGE TRIMMER



LASER CUT BLADE

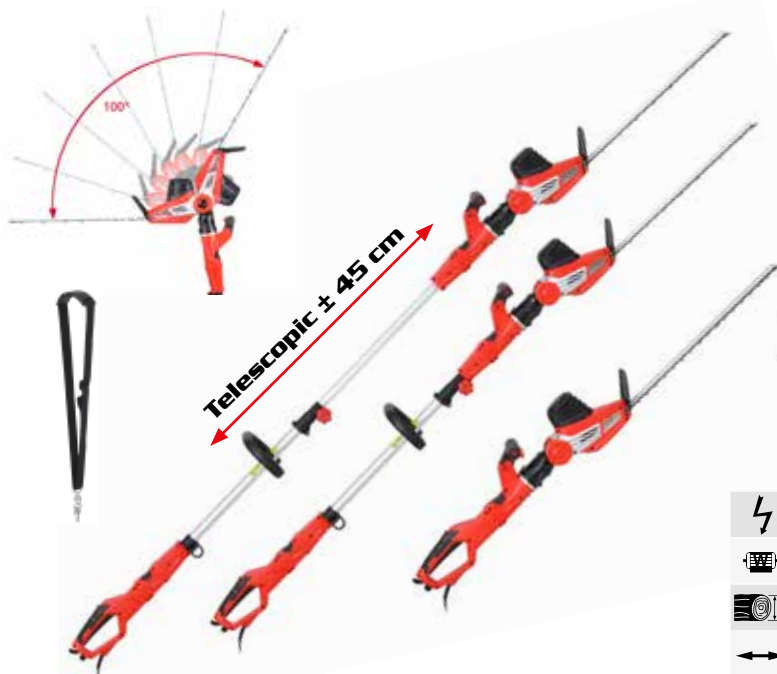

| | | | | | |
|--|---------------------------|-------------|--|--------------------|-------|
| | electric | 230 V/50 Hz | | bar length | 59 cm |
| | power input | 750 W | | bar working length | 51 cm |
| | max. cutting diameter | 24 mm | | weight | 5 kg |
| | machine length 2,35–2,8 m | | | | |

HECHT 1441

ACCU HEDGE TRIMMER



ACCU program 5040

Li-ion
Powered



| Optional accessories | Optional accessories |
|----------------------|----------------------|
| 1. HECHT 00144163 | 4. HECHT 00144161 |
| 2. HECHT 00144160 | 5. HECHT 00144166 |
| 3. HECHT 00144162 | 6. HECHT 00144165 |

| | | | | | |
|--|----------------------------------|-------------------------|--|----------------------------|-----------|
| | Accu Li-ion | DC 40 V / 1x 2,5/4/5 Ah | | weight without accessories | 3,95 kg |
| | working width grass trimmer | 25,4 cm | | bar length saw | 25 cm |
| | working width tiller | 25 cm | | bar length hedgetrimmer | 40,5 cm |
| | battery and charger not included | | | machine length | 1,9–2,4 m |

HECHT 690 3in1

ELECTRIC HEDGE TRIMMER



3in1

LASER CUT BLADE

| | | | | | |
|--|-------------|-------------|--|----------------------------|-------|
| | electric | 230 V/50 Hz | | bar length saw | 23 cm |
| | power input | 900 W | | bar length hedgetrimmer | 41 cm |
| | weight | 2,5 kg | | working width hedgetrimmer | 36 cm |

HECHT 971 W

ELECTRIC PRUNNING SAW

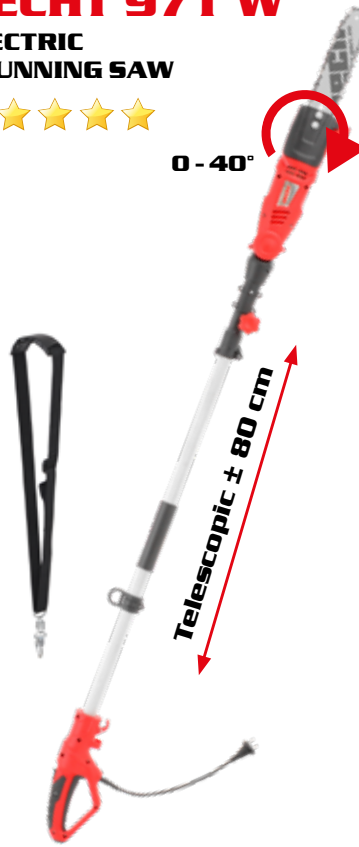

0 - 40°

Telescopic ± 80 cm

| | | | | | |
|--|----------------|-------------|--|------------|--------|
| | electric | 230 V/50 Hz | | bar length | 30 cm |
| | power input | 750 W | | weight * | 3,2 kg |
| | machine length | 2-2,8 m | | | |

HECHT 9260

PETROL PRUNNING SAW

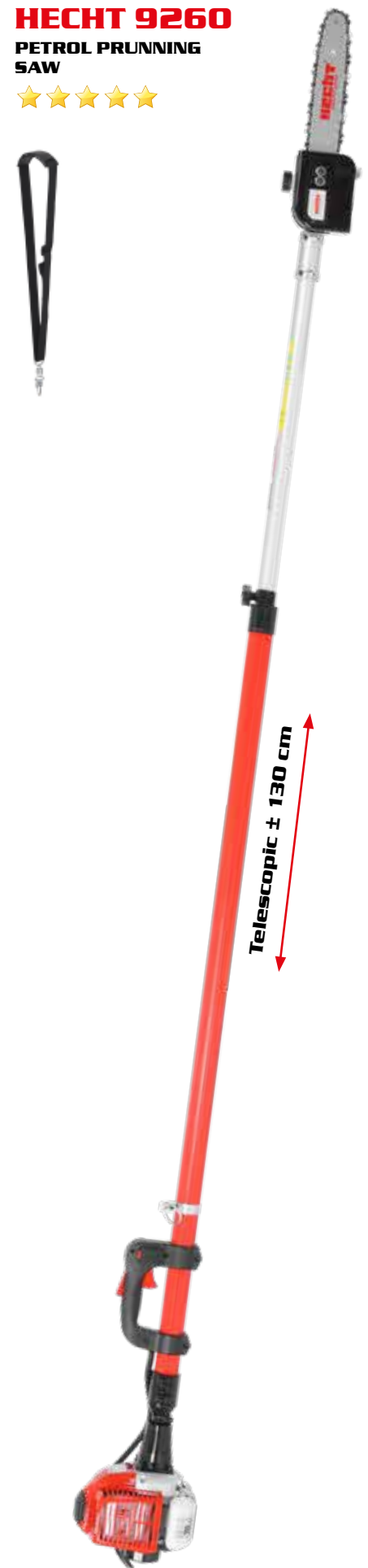

Telescopic ± 130 cm

HECHT 9025

ACCU PRUNNING SAW



Li-ion Powered

ACCU program 6020



Telescopic ± 50 cm



Bar + chain OREGON

HECHT 9504

ACCU PRUNNING SAW



Li-ion Powered

ACCU program 5040



Telescopic ± 50 cm



Bar + chain OREGON

| | | | | | |
|--|----------------------------------|--------------------|--|------------|--------|
| | Accu Li-ion | DC 20V / 1x 2,5 Ah | | bar length | 20 cm |
| | machine length | 2-2,5 m | | weight * | 3,5 kg |
| | battery and charger not included | | | | |

| | | | | | |
|--|----------------------------------|------------------------|--|----------------|-----------|
| | Accu Li-ion | DC 40V / 1x 2,5/4/5 Ah | | weight | 4,4 kg |
| | bar length | 20 cm | | machine length | 2,3-2,8 m |
| | battery and charger not included | | | | |

| | | | | | |
|--|----------------|--------------------|--|------------|--------|
| | engine volume | 26 cm ³ | | bar length | 34 cm |
| | power output | 1 HP | | weight * | 8,5 kg |
| | machine length | 2,96-4,27 m | | | |

* Maximum working time without load with 2 Ah battery.

ELECTRIC AND ACCU CHAINSAWS

Sprocket teeth detail



Metal gearbox



HECHT 2039

ELECTRIC CHAINSAW



TOP VIEW



| | | | | | |
|--|-------------|-------------|--|-------------|----------|
| | electric | 230 V/50 Hz | | bar length | 35 cm |
| | power input | 2200 W | | chain type | 33E52E |
| | weight * | 4,2 kg | | chain speed | 13,5 m/s |

Metal gearbox



HECHT 2260

ELECTRIC CHAINSAW



TOP VIEW



Soft start – starting capacitor for reduction of starting current

| | | | | | |
|--|-------------|-------------|--|-------------|--------|
| | electric | 230 V/50 Hz | | bar length | 40 cm |
| | power input | 2400 W | | chain type | 33E57E |
| | weight * | 5,6 kg | | chain speed | 14 m/s |
| | soft start | ✓ | | | |

Sprocket teeth detail



Metal gearbox



HECHT 2416 QT

ELECTRIC CHAINSAW



TOP VIEW



Soft start – starting capacitor for reduction of starting current

| | | | | | |
|--|-------------|-------------|--|----------------------------|--------|
| | electric | 230 V/50 Hz | | bar length | 40 cm |
| | power input | 2400 W | | chain type | 33E57E |
| | weight * | 4,7 kg | | chain speed | 14 m/s |
| | soft start | ✓ | | quick chain tension system | ✓ |

Sprocket teeth detail



Metal gearbox



HECHT 2439

ELECTRIC CHAINSAW



TOP VIEW



Soft start – starting capacitor for reduction of starting current

| | | | | | |
|--|-------------|-------------|--|----------------------------|----------|
| | electric | 230 V/50 Hz | | bar length | 40 cm |
| | power input | 2400 W | | chain type | 33E57E |
| | weight * | 5 kg | | chain speed | 13,5 m/s |
| | soft start | ✓ | | quick chain-tension system | ✓ |

www.hecht.cz

Bar + chain
OREGON

Bar + chain
OREGON

NEW

HECHT 99126

ACCU SHEARS AND CHAIN SAW

(Not intended for DE)



Transport bag
& spare chain
included



| | | | | | |
|--|----------------------------------|--------------|--|---|----------|
| | accu | DC 14,4V | | bar length | 10,16 cm |
| | weight * | 0,8 / 1,3 kg | | chain type | 14E28E |
| | max. cutting diameter | 30 mm | | chain speed | 6 m/s |
| | 2 batteries and charger included | ✓ | | 2-speed shears, quick chain tension system | |

ACCU
program
1278

Li-ion
Powered

ECO
FRIENDLY

HECHT 9922

ACCU CHAIN SAW



Working time
≤ 20 min.**

| | | | | | |
|--|----------------------------------|----------------------------|--|-------------|--------|
| | accu Li-ion | DC 20 V / 1× 2/4/6/8 Ah | | bar length | 11 cm |
| | weight * | 1,33 kg | | chain type | 14E32E |
| | battery and charger not included | | | chain speed | 5 m/s |

ACCU CHAINSAWS

ACCU program 1278
Li-ion
Powered



HECHT 9920

ACCU CHAIN SAW



Bar + chain
OREGON

Working time
≤ 13 min.**
Quick chain
tension system
TOP VIEW



| | | | | | |
|---|----------------------------------|----------------------------|--|-------------|--------|
| ⚡ | accu Li-ion | DC 20 V / 1× 2/4/6/8 Ah | | bar length | 25 cm |
| ⚖ | weight * | 3,14 kg | | chain type | 33E40E |
| | battery and charger not included | | | chain speed | 6 m/s |

ACCU program 6020
Li-ion
Powered



HECHT 920

ACCU CHAIN SAW



Bar + chain
OREGON



Quick chain
tension system

Working
time
≤ 15 min.



| | | | | | |
|---|----------------------------------|------------------------|--|-------------|---------|
| ⚡ | accu Li-ion | DC 20 V / 1× 2,5 Ah | | bar length | 30,5 cm |
| ⚖ | weight * | 3,2 kg | | chain type | 31E40E |
| | battery and charger not included | | | chain speed | 5,5 m/s |

ACCU program 5040
Li-ion
Powered



HECHT 9936

ACCU CHAINSAW



Li-ion
Powered

Working time
≤ 50 min.

Bar + chain
OREGON



Quick chain
tension system



| | | | | | |
|---|----------------------------------|----------------------------|--|-------------|---------|
| ⚡ | accu Li-ion | DC 40 V / 1× 2,5/4/5 Ah | | bar length | 35 cm |
| ⚖ | weight * | 3,8 kg | | chain type | 31E52E |
| | battery and charger not included | | | chain speed | 8,5 m/s |

ACCU program 6020
Li-ion
Powered



HECHT 9925

ACCU CHAINSAW



Li-ion
Powered

Working time
≤ 20 min.

Bar + chain
OREGON



Auto oiling
Quick chain tension system
Metal spike

2× 20 V



| | | | | | |
|---|----------------------------------|------------------------|--|------------------|--------|
| ⚡ | accu Li-ion | DC 20 V / 2× 2,5 Ah | | bar length | 30 cm |
| ⚖ | weight * | 3,2 kg | | chain type | 31E45E |
| | battery and charger not included | | | max. chain speed | 12 m/s |

ACCU program 5040
Li-ion
Powered



HECHT 9940

ACCU CHAINSAW



Li-ion
Powered



Quick chain
tension system

Working time
≤ 40 min.



| | | | | | |
|---|----------------------------------|----------------------------|--|-------------|--------|
| ⚡ | accu Li-ion | DC 40 V / 1× 2,5/4/5 Ah | | bar length | 35 cm |
| ⚖ | weight * | 5,5 kg | | chain type | 33E52E |
| | battery and charger not included | | | chain speed | 9 m/s |

ACCU program 6260
Li-ion
Powered



HECHT 6294

ACCU CHAINSAW



Li-ion
Powered



Bar + chain
OREGON

Replaces the petrol
engine in terms
of performance

Working time
≤ 47 min.



| | | | | | |
|---|----------------------------------|----------------------------|--|-------------|-------------|
| ⚡ | accu Li-ion | DC 62 V / 1× 2,5 / 4 Ah | | bar length | 41 cm / 16" |
| ⚖ | weight * | 4,3 kg | | chain type | 31E57E |
| | battery and charger not included | | | chain speed | 6 m/s |

* Net weight of chainsaws is without guide bar and saw chain. ** Maximum working time without load with 2 Ah battery.

PETROL CHAINSAWS



hanger for belt

NEW

HECHT 924 R PETROL CHAINSAW

☆☆☆☆☆



Aluminium carters

| | | | | | |
|--|---------------|----------------------|--|-------------|-------------|
| | engine volume | 25,4 cm ³ | | bar length | 30 cm / 12" |
| | power output | 1 HP | | chain type | 33E44E |
| | weight * | 3 kg | | chain speed | 16,2 m/s |

HECHT 45 PETROL CHAINSAW

☆☆☆☆☆



Aluminium carters

| | | | | | |
|--|---------------|--------------------|--|-------------|----------|
| | engine volume | 45 cm ³ | | bar length | 40 cm |
| | power output | 2,7 HP | | chain type | 25Q66E |
| | weight * | 5,4 kg | | chain speed | 23,1 m/s |

HECHT 54 PETROL CHAINSAW

NEW



Aluminium carters

| | | | | | |
|--|---------------|--------------------|--|-------------|----------|
| | engine volume | 52 cm ³ | | bar length | 40 cm |
| | power output | 2,4 HP | | chain type | 25Q66E |
| | weight * | 5,4 kg | | chain speed | 20,8 m/s |

HECHT 50 BOX PETROL CHAINSAW WITH CASE

☆☆☆☆☆

Aluminium carters



| | | | | | |
|--|---------------|--------------------|--|-------------|----------|
| | engine volume | 50 cm ³ | | bar length | 40 cm |
| | power output | 2,9 HP | | chain type | 25Q66E |
| | weight * | 5,4 kg | | chain speed | 20,8 m/s |

HECHT 56 PETROL CHAINSAW

☆☆☆☆☆



Aluminium carters

| | | | | | |
|--|---------------|----------------------|--|-------------|----------|
| | engine volume | 56,5 cm ³ | | bar length | 40 cm |
| | power output | 2,95 HP | | chain type | 25Q66E |
| | weight * | 5,72 kg | | chain speed | 21,8 m/s |

HECHT 62 PETROL CHAINSAW

☆☆☆☆☆



Aluminium carters

| | | | | | |
|--|---------------|--------------------|--|-------------|--------|
| | engine volume | 62 cm ³ | | bar length | 46 cm |
| | power output | 3,8 HP | | chain type | 25Q72E |
| | weight * | 5,4 kg | | chain speed | 23 m/s |

www.hecht.cz

PETROL CHAINSAWS, ACCESSORIES

HECHT 945 PETROL CHAINSAW



Carburetor WALBRO
Bar + chain OREGON
Aluminium carters

| | | | | | |
|--|---------------|--------------------|--|-------------|--------|
| | engine volume | 45 cm ³ | | bar length | 40 cm |
| | power output | 2,4 HP | | chain type | 25Q66E |
| | weight * | 5,6 kg | | chain speed | 23 m/s |

HECHT 950 PETROL CHAINSAW



Carburetor WALBRO
Bar + chain OREGON
Aluminium carters

| | | | | | |
|--|---------------|--------------------|--|-------------|--------|
| | engine volume | 50 cm ³ | | bar length | 40 cm |
| | power output | 3 HP | | chain type | 25Q66E |
| | weight * | 5,6 kg | | chain speed | 23 m/s |

HECHT 956 PETROL CHAINSAW



Carburetor WALBRO
Bar + chain OREGON
Aluminium carters

| | | | | | |
|--|---------------|--------------------|--|-------------|--------|
| | engine volume | 56 cm ³ | | bar length | 40 cm |
| | power output | 3,2 HP | | chain type | 25Q66E |
| | weight * | 5,6 kg | | chain speed | 23 m/s |

HECHT 962 PETROL CHAINSAW



Decompressor

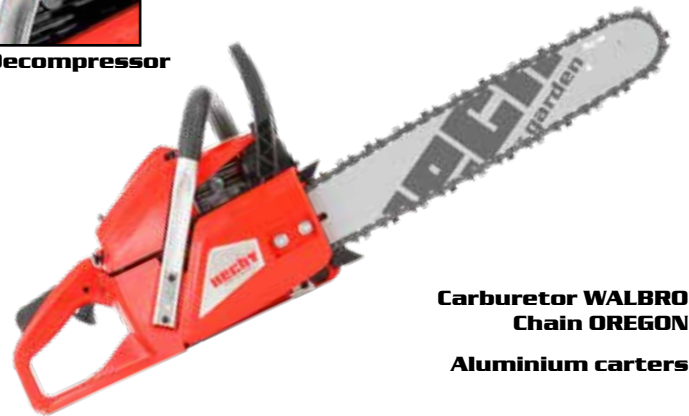

Carburetor WALBRO
Chain OREGON
Aluminium carters

| | | | | | |
|--|---------------|--------------------|--|-------------|----------|
| | engine volume | 62 cm ³ | | bar length | 45 cm |
| | power output | 4 HP | | chain type | 73E68E |
| | weight * | 6,3 kg | | chain speed | 24,4 m/s |

HECHT 1000R ENGINE TACHOMETER



LCD display,
induction cable,
battery, loop for
hanging

| Measuring range /min ⁻¹ | Engine type | |
|------------------------------------|-------------|----------|
| | Stroke | Cylinder |
| 100~19000 | 2 | 1 |
| | 4 | 2 |
| 100~9500 | 2 | 2 |
| | 4 | 4 |

HECHT 900101 FACE SHIELD



HECHT 900100 SAFETY HELMET WITH FACE SHIELD AND EAR PROTECTION



HECHT 900407 CARBURATOR ADJUSTER SET

Blister

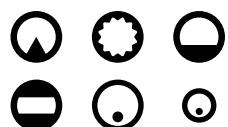

HECHT 900106 SAFETY GOGGLES



HECHT 900402 TIMBER WEDGE 8"

Blister



* Net weight of chainsaws is without guide bar and saw chain

CHAINSAW ACCESSORIES

The original chains HECHT for chainsaws

| THE ORIGINAL BARS HECHT FOR CHAINSAWS | |
|---|--------------------------------------|
| CHAINSAW | BAR |
| HECHT 939 from 2014, 939 S, 941, 1835, 2014, 2035, 2036, 2037, 3518, 9940, 2039 | 14" 3/8" 1,3 mm 14D38R135 |
| HECHT 45, 50, 56, 58, 944, 945, 946, 946 T, 947, 951, 953, 957, 958 | 16" 3/8" 1,5 mm 16D325R155 |
| HECHT 2239, 2250, 2416 QT, 2439, 939 do 2013 | 16" 3/8" 1,3 mm 16D38R135 |
| HECHT 26, 927, 927 R, 928 R, 929, 929 R | 12" 3/8" 1,3 mm 12D38R135 |
| HECHT 62 | 18" 3/8" 1,5 mm 18D325R155 |

| |
|--|
| 73E25R Roll |
| 3/8 – 1,5 mm, 410 links, 7,6 m |
| 25Q100R Roll |
| 0,325 – 1,5 mm, 1840 links, 30,5 m |
| 75E25R Roll |
| 3,8 – 1,6 mm, 409 links, 7,6 m |
| 33E100R Roll |
| 3/8 micro – 1,3 mm, 1640 links, 30,5 m |
| 95Q100R Roll |
| 0,325–1,3 mm, 1840 links, 30,5 m |

| ORIGINAL CHAINS TO HECHT CHAINSAWS | | |
|---|------------------------|---------------|
| CHAINSAW | CHAIN | |
| HECHT 9922, 99123 | 14E32E | |
| HECHT 99126 | 14E28E | |
| HECHT 946 T, 945, 950, 44, 45, 46, 50, 51, 54, 56, 944, 956 | 25Q66E | |
| HECHT 927 (do 2015), 9920, 971W, 9750 | 33E40E | |
| HECHT 9936 | 31E52E | |
| HECHT 6294 | 31E57E | |
| HECHT 936 | 33E45E | |
| HECHT 920 | 31E40E | |
| HECHT 9925 | 31E45E | |
| HECHT 1331 | 33E39E | |
| HECHT 1840, 2040, 2040 QT, 2048, 2440, 2240 QT, 2416 QT, 2439, 2250 | 33E57E | |
| HECHT 2216 | 33E56E | |
| HECHT 956 | 25Q72E | |
| HECHT 927 R, 928 R, 929, 927, 9260 | 33E44E | |
| HECHT 947, 950, 956, 951, 957 | 25Q66E | |
| HECHT 975 W, 955 W, 976 W, 9504 | 33E33E | |
| HECHT 1835, 1836, 3518, 941, 2014, 2015, 939 S, 939 | 33E53E | |
| HECHT 2035, 2036, 2037, 9940, 2039 | 33E52E | |
| WARIOR 645, RAPTOR 243 | 25Q64E | |
| HECHT 962 | chain bar Oregon 45 cm | 73E64E |
| | chain bar Oregon 50 cm | 48Y72E |
| | chain bar Hecht 45 cm | 73E68E |

www.hecht.cz



HECHT 000320

CHAINSAW FILE 3,2 MM

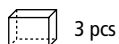

3 pcs

HECHT 000040

CHAINSAW FILE 4 MM

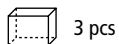

3 pcs

HECHT 000048

CHAINSAW FILE 4,8 MM

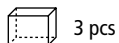

3 pcs

HECHT 900051

CHAINSAW FILE 5,5 MM

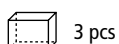

3 pcs



HECHT 903400

CHAIN SAW SHARPENING KIT

Files 4 mm

HECHT 903480

CHAIN SAW SHARPENING KIT

Files 4,8 mm

HECHT 004048

CHAIN SAW SHARPENING KIT

Files 4 mm,
4,8 mm, 5,5 mm



HECHT 900009

SAW CHAINS SHARPENING TOOL,
file 4 mm included





Carrying case included

HECHT 9588

PETROL CUT-OFF CHAIN SAW



Spare saw blade

nr.: 958800134



HECHT 9744

PETROL CUT-OFF CHAIN SAW



Plastic carrying case with rollers included

| | | | | | |
|--|---------------|--------------------|--|----------------|--------|
| | engine volume | 54 cm ³ | | blade diameter | 305 mm |
| | power output | 3,4 HP | | weight | 9,8 kg |

| | | | | | |
|--|---------------|--------------------|--|----------------|---------|
| | engine volume | 74 cm ³ | | blade diameter | 350 mm |
| | power output | 4,8 HP | | weight | 10,1 kg |

HECHT 9

CHAIN SHARPENER



SPARE GRINDING WHEELS

H928 (3,2 × 100 × 10)

H928A (4,5 × 100 × 10)



3,2 × 100 mm grinding wheel included

| | | | | | |
|--|-------------|-------------|--|---------------|--------|
| | electric | 230 V/50 Hz | | weight | 1,4 kg |
| | power input | 250 W | | disc diameter | 100 mm |

SPARE GRINDING WHEELS

9230A0007 (145 × 3,2 × 22,3)

9230B0007 (145 × 4,7 × 22,3)

9230C0007 (145 × 6 × 22,3)

Positionable

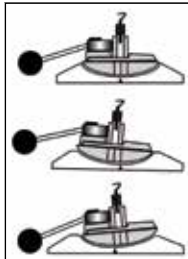

145 × 22,3 × 3,2 mm grinding wheel included

| | | | | | |
|--|-------------|-------------|--|---------------|--------|
| | electric | 230 V/50 Hz | | weight | 4,8 kg |
| | power input | 230 W | | disc diameter | 145 mm |

HECHT 9230

CHAIN SHARPENER



HECHT 900450

TRANSPORT PAD FOR CHAINSAW



HECHT A958P

SPARK PLUG FOR 2-STROKE ENGINES

thread length 9,5 mm, M14×1,25, key 19 mm



HECHT A969P

SPARK PLUG FOR 4-STROKE ENGINES

thread length 19 mm, M14×1,25, key 21 mm



HECHT 002850

START ROPE Ø 2,8 mm, 50 m, material PE

HECHT 003450

START ROPE Ø 3,4 mm, 50 m, material PE

HECHT 003850

START ROPE Ø 3,8 mm, 50 m, material PE

HECHT 000550

START ROPE Ø 5 mm, 50 m, material PE



HECHT 000045

GREASE GUN FOR CHAINSAW CHAINS

Grease filling included



HECHT 900404

FILING STUMP VISE



AXES, PICK AXE, HAMMER

HECHT 900600

UNIVERSAL AXE

Length 30 cm,
Weight 600 g*



Handle made of a special composite material which is reinforced with glass fibers.
- FIBERGLASS

HECHT 901000

UNIVERSAL AXE

Length 40 cm,
Weight 1000 g*



Handle made of a special composite material which is reinforced with glass fibers.
- FIBERGLASS

HECHT 901500

UNIVERSAL AXE

Length 55 cm
Weight 1500 g*



Handle made of a special composite material which is reinforced with glass fibers.
- FIBERGLASS

HECHT 900444

UNIVERSAL AXE

Length 35 cm
Weight 650 g*



Handle made of a special composite material which is reinforced with glass fibers.
- FIBERGLASS

HECHT 900700

UNIVERSAL AXE

Length 44 cm
Weight 910 g*



Handle made of a special composite material which is reinforced with glass fibers.
- FIBERGLASS

HECHT 900570 **TEFLON COATED BLADE**

UNIVERSAL AXE

Length 35 cm
Weight 570 g*



Handle made of a special composite material which is reinforced with glass fibers.
NYLON + FIBERGLASS

HECHT 900950 **TEFLON COATED BLADE**

SPLITTING AXE

Length 44 cm
Weight 950 g*

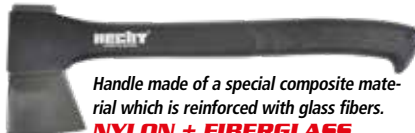

Handle made of a special composite material which is reinforced with glass fibers.
NYLON + FIBERGLASS

HECHT 901550 **TEFLON COATED BLADE**

SPLITTING AXE

Length 70 cm
Weight 1550 g*



Handle made of a special composite material which is reinforced with glass fibers.
NYLON + FIBERGLASS

HECHT 909100

PICK AXE

Length 91 cm



Handle made of a special composite material which is reinforced with glass fibers.
- FIBERGLASS

HECHT 909200

HAMMER

Length 90,5 cm, weight 4000 g*



Handle made of a special composite material which is reinforced with glass fibers.
- FIBERGLASS

HECHT 900680

UNIVERSAL AXE

Length 38 cm,
Weight 1000 g*



Handle made of a special composite material which is reinforced with glass fibers.
- FIBERGLASS

HECHT 901001

SPLITTING AXE

Length 40 cm
Weight 1000 g*



Handle made of a special composite material which is reinforced with glass fibers.
- FIBERGLASS

HECHT 901201

SPLITTING AXE

Length 55 cm
Weight 1200 g*



Handle made of a special composite material which is reinforced with glass fibers.
- FIBERGLASS

HECHT 902000

SPLITTING AXE

Length 63 cm
Weight 2000 g*



Handle made of a special composite material which is reinforced with glass fibers.
- FIBERGLASS

HECHT 900800

UNIVERSAL AXE

Length 59 cm
Weight 1130 g*



Handle made of a special composite material which is reinforced with glass fibers.
- FIBERGLASS

TEFLON COATED BLADE

HECHT 900901

UNIVERSAL AXE

Length 44 cm
Weight 900 g*



Handle made of a special composite material which is reinforced with glass fibers.
NYLON + FIBERGLASS

TEFLON COATED BLADE

HECHT 901170

SPLITTING AXE

Length 59 cm
Weight 1170 g*

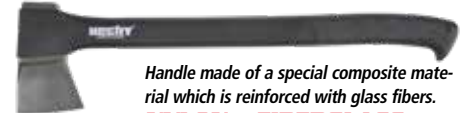

Handle made of a special composite material which is reinforced with glass fibers.
NYLON + FIBERGLASS

TEFLON COATED BLADE

HECHT 902550

SPLITTING AXE

Length 80 cm
Weight 2550 g*



Handle made of a special composite material which is reinforced with glass fibers.
NYLON + FIBERGLASS

HECHT 908500

SPLITTING AXE

Length 85 cm
Weight 2700 g*



Handle made of a special composite material which is reinforced with glass fibers.
- FIBERGLASS

HECHT 903600

SPLITTING AXE

Length 91 cm
Weight 3600 g*

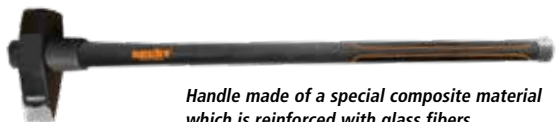

Handle made of a special composite material which is reinforced with glass fibers.
- FIBERGLASS

LOG SAWS, LOG HORSES

Opening safety cover

HECHT 8220 ROCKER SAW

Opening safety cover

HECHT 8300 LOG SAW



| | | | | | |
|--|-------------|-------------|--|-------------------|--------|
| | electric | 230 V/50 Hz | | max. log diameter | 135 mm |
| | power input | 2200 W | | weight | 38 kg |
| | saw blade | ø 405 mm | | | |

| | | | | | |
|--|-------------|-------------|--|-------------------|---------|
| | electric | 230 V/50 Hz | | max. log diameter | 170 mm |
| | power input | 3000 W | | weight | 56,6 kg |
| | saw blade | ø 505 mm | | | |

Opening safety cover

HECHT 850 LOG SAW

Opening safety cover

HECHT 890 PETROL LOG SAW



| | | | | | |
|--|-------------|-------------|--|-------------------|---------|
| | electric | 400 V/50 Hz | | max. log diameter | 250 mm |
| | power input | 5000 W | | weight | 92,5 kg |
| | saw blade | ø 700 mm | | | |

| | | | | | |
|--|---------------|---------------------|--|-------------------|--------|
| | engine volume | 389 cm ³ | | max. log diameter | 230 mm |
| | power output | 10,5 HP | | weight | 133 kg |
| | saw blade | ø 700 mm | | | |

HECHT 900 LOG CUTTING STAND

HECHT 901 LOG SAW HORSE

HECHT 902 LOG HORSE WITH CHAINSAW HOLDER *(The saw is not included)*



| | | |
|--|--------------|------------------|
| | log diameter | 25–230 mm |
| | dimensions | 120 × 37 × 95 cm |
| | max load | 110 kg |
| | weight | 12 kg |

*Not intended for
UK, D, FR, IT, A, CH*

| | | | | | |
|--|--------------|-------------------|--|--------------------|--------|
| | log diameter | 25–300 mm | | max load | 150 kg |
| | weight | 6 kg | | material thickness | 1,5 mm |
| | dimensions | 80 × 79 × 81,5 cm | | | |

| | | |
|--|--------------|-----------|
| | log diameter | 25–230 mm |
| | dimensions | 180 cm |
| | max load | 120 kg |
| | weight | 12 kg |

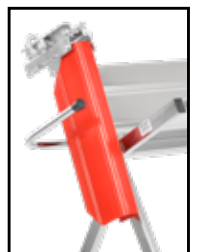

WEDGE SPLITTERS



Part no.:
HECHT 000650

HECHT 6700 WEDGE SPLITTER



| | | | | |
|---|---------------|-------------|--------------|------------|
| ⚡ | electric | 230 V/50 Hz | log length | 100-370 mm |
| ⚡ | power input | 2000 W | log diameter | 50-250 mm |
| ⚡ | max. pressure | 4 t | weight | 41 kg |

HECHT 000651

Stand for
HECHT 6500



HECHT 6500 WEDGE SPLITTER



Part no.:
HECHT 000650

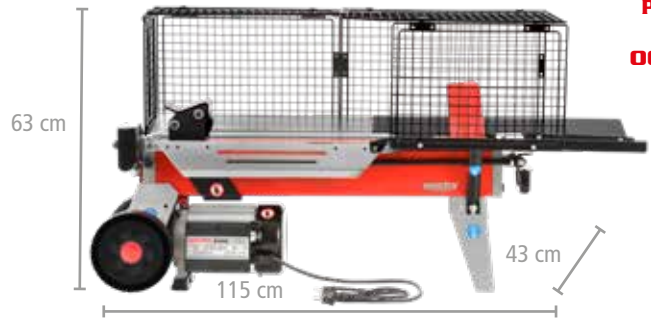

| | | | | |
|---|---------------|-------------|--------------|------------|
| ⚡ | electric | 230 V/50 Hz | log length | 100-520 mm |
| ⚡ | power input | 2200 W | log diameter | 50-250 mm |
| ⚡ | max. pressure | 5 t | weight | 50 kg |

HECHT 000670

STAND FOR
HECHT 670



HECHT 670 WEDGE SPLITTER



Part no.:
HECHT 000671



| | | | | |
|---|---------------|-------------|--------------|------------|
| ⚡ | electric | 230 V/50 Hz | log length | 100-520 mm |
| ⚡ | power input | 2000 W | log diameter | 50-250 mm |
| ⚡ | max. pressure | 7 t | weight | 41 kg |

HECHT 676 WEDGE SPLITTER



Part no.:
HECHT 000671

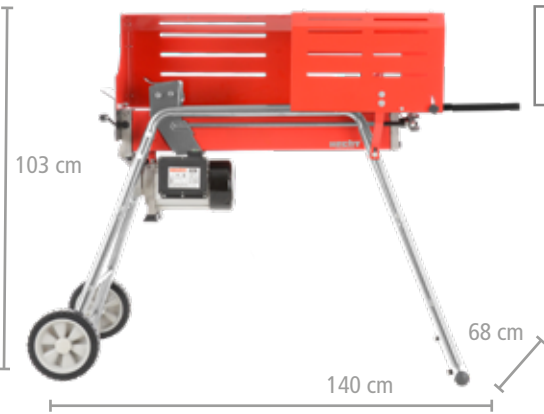

| | | | | |
|---|---------------|-------------|--------------|------------|
| ⚡ | electric | 230 V/50 Hz | log length | 100-520 mm |
| ⚡ | power input | 2000 W | log diameter | 50-250 mm |
| ⚡ | max. pressure | 7 t | weight | 48 kg |

HECHT 6910 KINETIC WOOD SPLITTER

YouTube



Part no.:
HECHT 006060

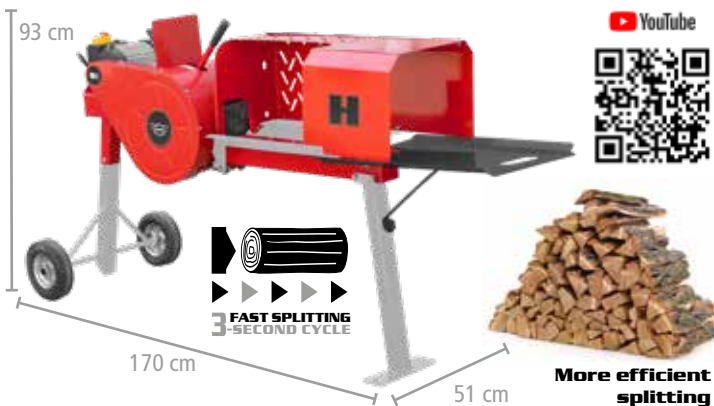

| | | | | |
|---|---------------|-------------|----------------|-----------|
| ⚡ | electric | 230 V/50 Hz | log length | 520 mm |
| ⚡ | power input | 1800 W | log diameter | 50-300 mm |
| ⚡ | max. pressure | 10 t | weight | 76 kg |
| 🕒 | cycle time | 3 s | ✓ metal wheels | |

HECHT 6060 WEDGE SPLITTER



| | | | | |
|----|---------------|-------------|--------------|------------|
| ⚡ | electric | 230 V/50 Hz | log length | 100-550 mm |
| ⚡ | power input | 2200 W | log diameter | 70-400 mm |
| ⚡ | max. pressure | 6 t | weight | 105 kg |
| ⬆️ | piston stroke | 480 mm | | |

WEDGE SPLITTERS



Part no.:
**HECHT
006070**



HECHT 6070 WEDGE SPLITTER

| | | | | |
|---|---------------|-------------|--------------|------------|
| ⚡ | electric | 230 V/50 Hz | log length | 100-550 mm |
| | power input | 3000 W | log diameter | 80-300 mm |
| | max. pressure | 7 t | weight | 98 kg |
| | piston stroke | 495 mm | | |



Part no.:
**HECHT
000681**



HECHT 6810 WEDGE SPLITTER

| | | | | |
|---|---------------|-------------|--------------|------------|
| ⚡ | electric | 230 V/50 Hz | log length | 100-550 mm |
| | power input | 3000 W | log diameter | 80-400 mm |
| | max. pressure | 8 t | weight | 112 kg |
| | piston stroke | 495 mm | | |



HECHT 6110 WEDGE SPLITTER

Auxiliary arm
for lifting the log



| | | | | |
|---|---------------|-------------|--------------|------------|
| ⚡ | electric | 230 V/50 Hz | log length | 100-700 mm |
| | power input | 3000 W | log diameter | 80-300 mm |
| | max. pressure | 10 t | weight | 98 kg |
| | piston stroke | 628 mm | | |



HECHT 6121 WEDGE SPLITTER

Auxiliary arm
for lifting the log



| | | | | |
|---|---------------|-------------|--------------|------------|
| ⚡ | electric | 230 V/50 Hz | log length | 100-700 mm |
| | power input | 3000 W | log diameter | 80-350 mm |
| | max. pressure | 12 t | weight | 98 kg |
| | piston stroke | 628 mm | | |



HECHT 6160 WEDGE SPLITTER

Auxiliary arm
for lifting the log



| | | | | |
|---|---------------|-------------|--------------|-------------|
| ⚡ | electric | 400 V/50 Hz | log length | 100-1000 mm |
| | power input | 4000 W | log diameter | 80-400 mm |
| | max. pressure | 16 t | weight | 180 kg |
| | piston stroke | 923 mm | | |



4-STROKE

Towing rod



HECHT 6422 PETROL WEDGE SPLITTER

VARIO
SYSTEM*

Wheels 16"
without brake

177 cm



| | | | | |
|--|---------------|---------------------|---------------|------------|
| | engine B&S | XR950 | log length | 100-610 mm |
| | displacement | 208 cm ³ | log diameter | 80-350 mm |
| | max. torque | 12,88 Nm | weight | 246 kg |
| | max. pressure | 22 t | piston stroke | 640 mm |

* Axes are weighted as a splitting wedge without handle.

ELECTRIC SHREDDERS

Shredded branches



Including ca. 50 l bag

Turbo engine



HECHT 625 KNIVES SHREDDER



The knives gradually cut small parts from the branches at high speed, which can be used for mulching flower beds, they are also suitable for compost, where they quickly decompose.

Knife shredders can cope well with fresh and larger branches.

Shredded branches



Box ca. 60 l

Turbo engine



HECHT 626 BOX KNIVES SHREDDER



The knives gradually cut small parts from the branches at high speed, which can be used for mulching flower beds, they are also suitable for compost, where they quickly decompose.

Knife shredders can cope well with fresh and larger branches.

| | | | | | |
|--|------------------------------|-------------|--|--------------------|----------|
| | electric | 230 V/50 Hz | | cut branches up to | 4,5 cm |
| | power input | 2500 W | | weight | 10,5 kg |
| | electric overload protection | ✓ | | collecting bag | cca 50 l |

| | | | | | |
|--|------------------------------|-------------|--|--------------------|----------|
| | electric | 230 V/50 Hz | | cut branches up to | 4,5 cm |
| | power input | 2600 W | | weight | 11,7 kg |
| | electric overload protection | ✓ | | collecting box | cca 60 l |

NEW

Shredded branches



Induction carbon engine



HECHT 627 Silent CYLINDER SHREDDER



The branches are pulled between the teeth and the plate and are cut into 1-3 cm large pieces.

The pulp is suitable i.e. for heating or as a mulch.

Collecting bag included

Shredded branches



Box ca. 60 l

Induction carbon engine



HECHT 6284 XL KNIVES SHREDDER



The knives gradually cut small parts from the branches at high speed, which can be used for mulching flower beds, they are also suitable for compost, where they quickly decompose.

Knife shredders can cope well with fresh and larger branches.

| | | | | | |
|--|--|-------------|--|--------------------------|-------|
| | electric | 230 V/50 Hz | | cut branches up to | 4 cm |
| | power input | 2500 W | | automatic branch pulling | ✓ |
| | electric overload protection | ✓ | | weight | 25 kg |
| | shredding by crushing roller (very silent) | ✓ | | collecting bag | 65 l |

| | | | | | |
|--|------------------------------|-------------|--|--------------------|----------|
| | electric | 230 V/50 Hz | | cut branches up to | 4,5 cm |
| | power input | 2800 W | | weight | 25 kg |
| | electric overload protection | ✓ | | collecting box | cca 60 l |

Shredded branches



Box ca. 60 l

Turbo engine



HECHT 6285 XL Silent CYLINDER SHREDDER



The branches are pulled between the teeth and the plate and are cut into 1-3 cm large pieces.

The pulp is suitable i.e. for heating or as a mulch.

Automatic branching

Shredded branches



Box ca. 60 l

Induction carbon engine



HECHT 6300 XL Silent CYLINDER SHREDDER



The branches are pulled between the teeth and the plate and are cut into 1-3 cm large pieces.

The pulp is suitable i.e. for heating or as a mulch.

Automatic branching

| | | | | | |
|--|--|-------------|--|--------------------------|----------|
| | electric | 230 V/50 Hz | | cut branches up to | 4,4 cm |
| | power input | 2800 W | | automatic branch pulling | ✓ |
| | electric overload protection | ✓ | | weight | 19,4 kg |
| | shredding by crushing roller (very silent) | ✓ | | collecting box | cca 60 l |

| | | | | | |
|--|--|-------------|--|--------------------------|----------|
| | electric | 230 V/50 Hz | | cut branches up to | 4,5 cm |
| | power input | 3000 W | | automatic branch pulling | ✓ |
| | electric overload protection | ✓ | | weight | 31,5 kg |
| | shredding by crushing roller (very silent) | ✓ | | collecting box | cca 60 l |

PETROL SHREDDERS, WOOD LOGGER

HECHT 6173

KNIVES SHREDDER



The knives gradually cut small parts from the branches at high speed, which can be used for mulching flower beds, they are also suitable for compost, where they quickly decompose.

Knife shredders can cope well with fresh and larger branches.

Shredded branches



Box ca. 30 l

| | | | | | |
|--|--------------|---------------------|--|--------------------------|----------|
| | displacement | 173 cm ³ | | cut branches up to | 3,6 cm |
| | max. torque | 9 Nm | | automatic branch pulling | |
| | weight | 38,5 kg | | collecting box | cca 30 l |

HECHT 6208

PETROL SHREDDER



Max. torque 13,5 Nm



99 cm

Shredded branches



| | | | | | |
|--|--------------|---------------------|--|--------------------------|------|
| | displacement | 212 cm ³ | | cut branches up to | 7 cm |
| | max. torque | 13,5 Nm | | automatic branch pulling | |
| | weight | 56 kg | | wheels | 8,7" |

HECHT 6421

PETROL SHREDDER



Max. torque 26,5 Nm

Shredded branches



Towing rod

Crushing toothed knives



| | | | | | |
|--|--------------|---------------------|--|--------------------------|--------|
| | displacement | 420 cm ³ | | cut branches up to | 8,9 cm |
| | max. torque | 26,5 Nm | | automatic branch pulling | |
| | weight | 100 kg | | wheels | 12" |

HECHT 6642

SHREDDING KNIVES

PETROL SHREDDER



Max. torque 28 Nm

Towing rod 2"



Shredded branches



| | | | | | |
|--|--------------|---------------------|--|--------------------------|-------|
| | displacement | 420 cm ³ | | cut branches up to | 10 cm |
| | max. torque | 28 Nm | | automatic branch pulling | |
| | weight | 180 kg | | wheels | 16" |



24" towing drawbar

Front wheels brakes

Adjustable height



CHOPS INTO

10-22 cm

HECHT 6645

PETROL WOOD LOGGER



Bag 120 l included



| | | | | | |
|--|--------------|---------------------|--|--|-------|
| | displacement | 457 cm ³ | | cuts branches up to Ø | 12 cm |
| | max. torque | 26 Nm | | automatic branch pulling | |
| | weight | 249 kg | | wheels | 16" |
| | chops into* | 10-22 cm | | 6 high quality knives, CE approved, not intended for operation on public roads | |

* The splitter is equipped with an integrated system, which helps to set any working path of the piston, according to the length of the log. The system effectively shortens the piston path and thus speeds up the splitting cycle.

ACCU AND ELECTRIC LEAF VACS / BLOWERS

ACCU program 6020

HECHT 9250

ACCU BLOWER

★★★★★

ECO FRIENDLY

Li-ion Powered



ACCU program 5040

HECHT 9440

ACCU LEAF VAC / BLOWER

★★★★★

ECO FRIENDLY

2 IN 1



LEAF VAC

ACCU program 6260

HECHT 6290

ACCU BLOWER

★★★★★

ECO FRIENDLY

Li-ion Powered



Replaces the petrol engine in terms of performance

| | | | | | |
|--|----------------------------------|---------|--|--------------|-------------------------|
| | accu Li-ion | DC 20 V | | air velocity | 162 km/h |
| | weight | 1,9 kg | | air volume | 7,5 m ³ /min |
| | battery and charger not included | | | | |

| | | | | | |
|--|-----------------------|-------------------------|--|----------------------------------|-------------------------|
| | Li-ion | DC 40 V / 1x 2,5/4/5 Ah | | air volume blower | 4,2 m ³ /min |
| | weight blower | 2,14 kg | | air volume vacuum cleaner | 6 m ³ /min |
| | weight vacuum cleaner | 2,88 kg | | battery and charger not included | |

| | | | | | |
|--|---------------|-------------------------|--|----------------------------------|--------------------------|
| | Li-ion | DC 62 V / 1x 2,5 / 4 Ah | | air volume | 18,5 m ³ /min |
| | weight | 2 kg | | air velocity | 55 m/s |
| | no-load speed | 28000 min ⁻¹ | | battery and charger not included | |



Air flow speed control



Metal blade

HECHT 3003

LEAF VAC / BLOWER

★★★★★



Air flow speed control



Rakes



2 IN 1

HECHT 3303

2 IN 1 LEAF VAC / BLOWER

★★★★★



LEAF VAC

| | | | | | |
|--|-------------|-------------|--|----------------|--------------------------|
| | electric | 230 V/50 Hz | | air velocity | 270 km/h |
| | power input | 3300 W | | air volume | 12,6 m ³ /min |
| | weight | 2,8 kg | | collecting bag | 45 l |

| | | | | | |
|--|-------------|-------------|--|----------------|--------------------------|
| | electric | 230 V/50 Hz | | air velocity | 280 km/h |
| | power input | 3000 W | | air volume | 13,8 m ³ /min |
| | weight | 4,1 kg | | collecting bag | 45 l |

HECHT 9254

2 IN 1 PETROL LEAF VAC / BLOWER

★★★★★

LEAF VAC



2 IN 1

BLOWER

HECHT 9280

2 IN 1 LEAF VAC / BLOWER

★★★★★

LEAF VAC



2 IN 1

BLOWER

2-stroke engine

| | | | | | |
|--|--------------------------|----------------------|--|----------------|-----------------------|
| | engine volume | 25,4 cm ³ | | air velocity | 245 km/h |
| | power output | 1 HP | | air volume | 6 m ³ /min |
| | weight without accessory | 5,8 kg | | collecting bag | 37 l |

2-stroke engine

adjustment of engine power

| | | | | | |
|--|--------------------------|--------------------|--|----------------|------------------------|
| | engine volume | 28 cm ³ | | air velocity | 252 km/h |
| | power output | 1 HP | | air volume | 12 m ³ /min |
| | weight without accessory | 4,5 kg | | collecting bag | 40 l |

PETROL LEAF VACS / BLOWERS

HECHT 943 PETROL BLOWER



Blower only



| | | | | | |
|--|---------------|--------------------|--|--------------|------------------------|
| | engine volume | 43 cm ³ | | air velocity | 223 km/h |
| | power output | 1,6 HP | | air volume | 15 m ³ /min |
| | weight | 6,5 kg | | | |

HECHT 952 PETROL BLOWER



Blower only



2-stroke engine

| | | | | | |
|--|---------------|--------------------|--|--------------|--------------------------|
| | engine volume | 52 cm ³ | | air velocity | 275 km/h |
| | power output | 1,9 HP | | air volume | 14,4 m ³ /min |
| | weight | 8,3 kg | | | |

4-stroke

HECHT 976 4T PETROL BLOWER



Blower only



4-stroke engine

| | | | | | |
|--|---------------|--------------------|--|--------------|--------------------------|
| | engine volume | 76 cm ³ | | air velocity | 309 km/h |
| | power output | 3 HP | | air volume | 19,2 m ³ /min |
| | weight | 13 kg | | | |

HECHT 972 PROFI PETROL BLOWER



Blower only



Filter for dusty environments

2-stroke engine

| | | | | | |
|--|---------------|----------------------|--|----------------------------|------------------------|
| | engine volume | 79,4 cm ³ | | air velocity | 378 km/h |
| | power output | 4,6 HP | | air volume | 24 m ³ /min |
| | weight | 11 kg | | adjustment of engine power | |

HECHT 8514 PETROL CLEANER / BLOWER

2 IN 1



58 cm

4-stroke engine

| | | | | | |
|--|-----------------------|---------------------|--|-------------------|------------------------|
| | engine volume | 173 cm ³ | | air velocity | 270 km/h |
| | max. torque | 9,9 Nm | | air volume | 18 m ³ /min |
| | weight | 46,6 kg | | height adjustment | 15-50 mm |
| | drive, 1 gear forward | | | collecting box | 135 l |

HECHT 008514 SWEEPING ROLLER FOR HECHT 8514 (NOT INCLUDED)



2 IN 1

HECHT 8574 PROFI PETROL CLEANER / SHREDDER



60 cm

4-stroke engine

| | | | | | |
|--|---------------|---------------------|--|----------------------------------|-------|
| | engine volume | 196 cm ³ | | cut branches up to | 5 cm |
| | max. torque | 13 Nm | | collecting box | 120 l |
| | weight | 96 kg | | 2 gears forward, 2 gears reverse | |





12in1
(12 products with 1 battery and charger)

HECHT 5025
LAWN MOWER

Slot for 2 batteries

Working time ≤ 20 min



PUSHED

More info on page 13

| | | | | | |
|--|---------------------|-----------|--|--------------------------------------|----------|
| | accu Li-ion | DC 20 V | | height adjustment | 25–65 mm |
| | Li-ion | 2× 2,5 Ah | | chassis | plastic |
| | working width | 32 cm | | collecting box | 26 l |
| | wheels (front/rear) | 5,5/6" | | central adjustment of cutting height | |

HECHT 6025
HEDGE TRIMMER

Working time ≤ 20 min

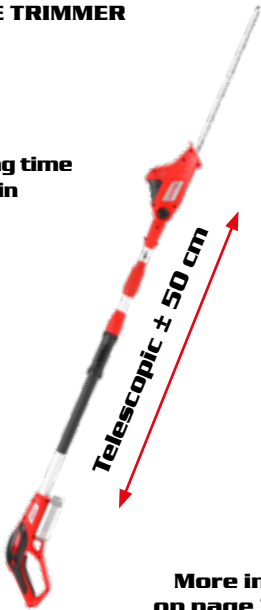

Telescopic ± 50 cm

More info on page 32

HECHT 9025
POLE PRUNER

Bar + chain OREGON
Working time ≤ 20 min

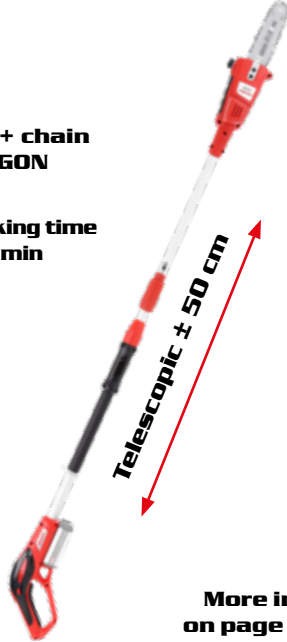

Telescopic ± 50 cm

More info on page 33

| | | | | | |
|--|----------------|------------------|--|------------|--------|
| | Accu Li-ion | DC 20 V / 2,5 Ah | | bar length | 50 cm |
| | max. cutting Ø | 15 mm | | weight | 3,5 kg |
| | length | 2–2,5 m | | | |

| | | | | | |
|--|----------------|------------------|--|------------|--------|
| | Accu Li-ion | DC 20 V / 2,5 Ah | | bar length | 20 cm |
| | max. cutting Ø | 15 mm | | weight | 3,5 kg |
| | length | 2–2,5 m | | | |

www.hecht.cz

HECHT 3025
HIGH-PRESSURE WASHER

Working time ≤ 20 min



More info on page 79

| | | | | | |
|--|----------------------|---------------------|--|---------------|--------|
| | Accu Li-ion | DC 20 V / 1× 2,5 Ah | | max. pressure | 22 bar |
| | max. delivery volume | 180 l/h | | weight | 1,3 kg |

Selfsuction hose included

HECHT 3425
HIGH-PRESSURE WASHER

Working time ≤ 20 min

Slot for 2 batteries

4m SELFSUCTION HOSE INCLUDED

2× 20 V

More info on page 79

| | | | | | |
|--|----------------------|------------|--|---------------|--------|
| | Accu Li-ion | 2× DC 20 V | | max. pressure | 40 bar |
| | max. delivery volume | 240 l/h | | weight | 3,5 kg |



HECHT 9250
BLOWER

Working time ≤ 10 min

More info on page 46

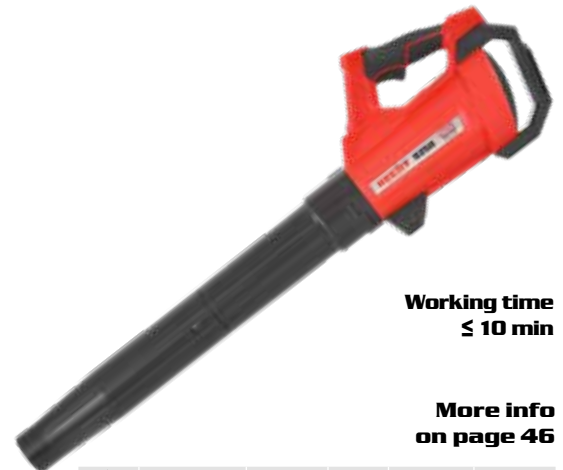

| | | | | | |
|--|------------------|---------------------|--|--------------|------------|
| | accumulator | Lithium-ion | | air velocity | 162 km/h |
| | accu article (V) | DC 20 V / 1× 2,5 Ah | | air volume | 7,5 m³/min |
| | weight | 1,9 kg | | | |



BATTERY 000625B
DC 20 V, 2,5 Ah

BATTERY 000640B
DC 20 V, 4 Ah

NEW

ACCU PROGRAM 6020 – 20 V

HECHT 5020 GRASS TRIMMER

Working time
≤ 20 min

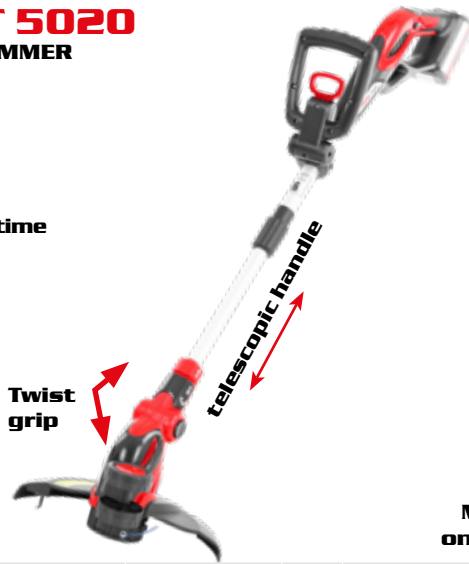

More info
on page 56

| | | | | | |
|--|---------------------------|----------------------|--|---------------|-------|
| | Accu Li-ion | DC 20 V / 1 × 2,5 Ah | | working width | 25 cm |
| | working time without load | cca 20 min | | weight | 2 kg* |

HECHT 7025 TILLER

Working time
≤ 20 min



More info
on page 25

| | | | | | |
|--|-------------|----------------------|--|---------------|--------|
| | Accu Li-ion | DC 20 V / 1 × 2,5 Ah | | working width | 20 cm |
| | 4x4 knives | | | weight | 3,4 kg |

Li-ion
Powered

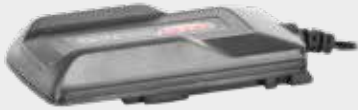

CHARGER
000620CH
input 230 V/50 Hz
output DC 20 V, 2 A

Charging time
approx. 2 h

HECHT 6020 HEDGE TRIMMER

Working time
≤ 50 min



More info
on page 30

| | | | | | |
|--|------------------|----------------------|--|------------|-------|
| | Accu Li-ion | DC 20 V / 1 × 2,5 Ah | | bar length | 45 cm |
| | cutting diameter | 15 mm | | weight | 2 kg |

HECHT 6225 HEDGE TRIMMER

2 × 20 V
Working time
≤ 50 min



More info
on page 31

| | | | | | |
|--|-------------|------------|--|------------------|-------|
| | Accu Li-ion | DC 20 V | | cutting diameter | 24 mm |
| | Li-ion | 2 × 2,5 Ah | | bar length | 55 cm |

HECHT 920 CHAIN SAW

Bar + chain
OREGON

Working time
≤ 15 min



More info
on page 35

| | | | | | |
|--|-------------|----------------------|--|-------------|---------|
| | Accu Li-ion | DC 20 V / 1 × 2,5 Ah | | bar length | 25,4 cm |
| | weight | 2,8 kg | | chain speed | 5,5 m/s |
| | | | | chain type | 31E40E |

HECHT 9925 CHAIN SAW

Working time
≤ 20 min



More info
on page 35

| | | | | | |
|--|-------------|------------|--|------------------|--------|
| | Accu Li-ion | DC 20 V | | bar length | 30 cm |
| | Li-ion | 2 × 2,5 Ah | | max. chain speed | 12 m/s |

* Net weight of grass trimmers and brush cutters is without cutting cover and tools, with battery.

**ACCU
program
1278**

You buy a drill HECHT 1277, HECHT 1278 or HECHT 1289 to have no longer to re-buy batteries for other products.

HECHT 5072

LAWN MOWER

NEW

More info on page 13



Available from 4/25

HECHT 5070

LAWN MOWER

More info on page 13



HECHT 1435

GRASS TRIMMER

More info on page 57

Available from 2/25



23 in 1

(23 products with the same battery)

HECHT 1278



Drills including 2 batteries and quick charger in package

HECHT 6022

HEDGE TRIMMER

Rotary handle



More info on page 30

Laser cut blade

Available from 2/25

HECHT 9922

CHAIN SAW



More info on page 34

HECHT 9920

CHAIN SAW

More info on page 35



HECHT 1142

PAINT AND MORTAR STIRRER

More info on page 83



NEW

Available from 4/25

HECHT 5022

GRASS TRIMMER

More info on page 56

Available from 3/25



502200033
PLASTIC BLADES
20 PCS

HECHT 1670

CIRCULAR SAW

HECHT 001670

SAW BLADE FOR WOOD
24 teeth, 150×10×1,6 mm



Laser

More info on page 98

PROFI TOOL

HECHT 1023

ROTARY HAMMER

Brushless motor

More info on page 93



www.hecht.cz

HECHT 1706
LED LIGHT

More info
on page 87



Rotary

HECHT 1708
LED LIGHT

More info
on page 87



HECHT 001277BX
SPARE BATTERY 2 Ah, 20 V



HECHT 001278BX
SPARE BATTERY 4 Ah, 20 V



HECHT 001289BX
SPARE BATTERY 6 Ah, 20 V



HECHT 001290BX
SPARE BATTERY 8 Ah, 20 V



NEW

Available
from 5/25

HECHT 1740
GARDEN SCISSORS

More info
on page 66



HECHT 1531
JIGSAW

More info
on page 95
Blade quick
release guard



HECHT 001277CH
QUICK 3 A SUPERCHARGER
input 230 V/50 Hz
output
DC 20 V, 3 A



HECHT 1277



HECHT 1289



More info
on page
91

HECHT 001289CH
QUICK 3 A SUPERCHARGER
FOR TWO BATTERIES
input 230 V/50 Hz
output DC
20 V, 3 A



HECHT 9410
SPRAYER
More info
on page 69



HECHT 1320
ANGLE GRINDER

More info
on page 95



HECHT 1510
RECIPROCATING SAW

More info
on page 98



PROFI TOOL

HECHT 1256
IMPACT WRENCH

Long life
brushless
motor



Available
from 3/25

More info on page 92

HECHT 2090
COMPRESSOR

Digital
display

Ideal for
inflating
tires, bicycles
or balls



Available
from 3/25

More info on page 88

NEW

HECHT 1515
STAPLER

Available
from 5/25

More info on page 94



ACCU PROGRAM 5040 – 40 V

HECHT 5034
LAWN MOWER



More info
on page 13

HECHT 5038
LAWN MOWER



More info
on page 13

HECHT 5041
LAWN MOWER



More info
on page 14

HECHT 5043
LAWN MOWER



More info
on page 14

HECHT 5045 S
LAWN MOWER



More info
on page 14

22in 1

22 products
with 1 battery
and charger

BATTERY HECHT
005025B
DC 40 V, 2,5 Ah



BATTERY HECHT
005040B
DC 40 V, 4 Ah



BATTERY HECHT
005050B
DC 40 V, 5 Ah

HECHT 1384
2 in 1
LAWN AERATOR



More info
on page 23

HECHT 6040
HEDGE TRIMMER

More info
on page 31

Laser cut
blade



HECHT 9440
VAC / BLOWER

More info
on page 46



2 IN 1

HECHT 9040
SNOW THROWER



More info
on page 61



ACCU PROGRAM 5040 – 40 V



HECHT 5041 S
LAWN MOWER

More info
on page 14



HECHT 5051 S 5in1
LAWN MOWER

Mulching kit included

More info
on page 14

Alternative side ejection

HECHT 9415
KNAPSACK
SPRAYER



More info
on page 70

HECHT 9504
POLE PRUNER



Bar + chain
OREGON

More info
on page 33

Telescopic ± 50 cm

ACCU
program
5040

CHARGER
HECHT
005046

input 230 V/50 Hz
output DC 40 V, 2 A



HECHT 1040
GRASS
TRIMMER



More info
on page 57

HECHT 1440
BRUSH CUTTER



More info
on page 57



HECHT
1441
MULTIFUNCTION
BRUSHCUTTER

More info
on page 32

HECHT 9936
CHAIN SAW

More info
on page 35



Quick chain
tension system

Bar + chain
OREGON

HECHT 9940
CHAIN SAW

More info
on page 35



Quick chain
tension system

Bar + chain
OREGON

| Optional accessories | Optional accessories |
|----------------------|----------------------|
| 1. HECHT 00144163 | 4. HECHT 00144161 |
| 2. HECHT 00144160 | 5. HECHT 00144166 |
| 3. HECHT 00144162 | 6. HECHT 00144165 |

* Net weight of grass trimmers and brush cutters is without cutting cover, tools and battery.

ORIGINAL ACCESSORIES

| | | HECHT MACHINE | | | | | | | | | | | | | | | | |
|-------------|-----------------------|---------------|------------|-----------|-------------|-------------|------------|------------|---------------|---------------|-----------------|---------------|-----------|-----------|---------------|-----------|-----------|----------------|
| item number | | HECHT 1299 | HECHT 1445 | HECHT 690 | HECHT 124 R | HECHT 126 R | HECHT 130R | HECHT 134R | HECHT 129.BTS | HECHT 135.BTS | HECHT 1330,1331 | HECHT 142.BTS | HECHT 145 | HECHT 151 | HECHT 152.BTS | HECHT 154 | HECHT 155 | HECHT 150, 163 |
| | HECHT 000109 | x | | | | | | | x | x | x | x | x | x | x | x | x | |
| | HECHT 000129* | | | | | | | x | | | | x | x | x | x | x | x | |
| | HECHT 000130 | | | | | | | | | | x | x | x | x | x | x | x | |
| | 74201080 | x | | | | | | | | | | | | | | | | |
| | 124R00004 | | | | x | x | x | | | | | | | | | | | |
| | 16300000H | | | | | | | | | | | | | | | | | x |
| | 690002432 | | | x | | | | | | | | | | | | | | |
| | 600050 ø 255x1,4mm | x | | | | | | x | x | x | x | x | x | x | x | x | x | |
| | 600040 ø 255x1,4mm | x | | | | | | x | x | x | x | x | x | x | x | x | x | |
| | 600250 ø 255x1,4mm | x | | | | | | x | x | x | x | x | x | x | x | x | x | |
| | 600600 ø 250x3,0mm | | | | | | | x | | | x | x | x | x | x | x | x | |
| | 600610 ø 300x3,0mm | | | | | | | x | | | x | x | x | x | x | x | x | |
| | 600590 ø 255x1,4mm | | | | | | | | | | | | | x | x | x | | |
| | 600640 ø 255x1,8mm | | | | | | | | | | | | | x | x | x | | |

Strings for grass trimmers HECHT

- Ø 1,3 x 15 m (10001513)
- Ø 1,65 x 15 m (10001516)
- Ø 2,0 x 15 m (10001520)
- Ø 2,4 x 15 m (10001524)
- Ø 2,4 x 15 m (10101524)
- ★ Ø 2,4 x 15 m (10201524)
- Ø 3,0 x 15 m (10101530)
- ★ Ø 3,0 x 15 m (10201530)



- Ø 1,6 x 180 m (10018016)
- Ø 2,0 x 130 m (10013020)
- Ø 2,4 x 90 m (10009024)
- Ø 3,0 x 60 m (10006030)
- Ø 2,4 x 60 m (10106024)
- Ø 3,0 x 40 m (10104030)
- ★ Ø 2,4 x 90 m (10209024)
- ★ Ø 3,0 x 60 m (10206030)



- Ø 2,4 x 360 m (10036024)
- Ø 3,0 x 240 m (10024030)
- Ø 4 x 150 m (10015040)
- Ø 2,4 x 345 m (10134524)
- Ø 3,0 x 232 m (10123230)
- ★ Ø 2,4 x 408 m (10240824)
- ★ Ø 3,0 x 285 m (10228530)



Strings with core – DUAL POWER

- Ø 1,65 x 15 m (10301516)
- Ø 1,65 x 180 m (10318016)
- Ø 2 x 15 m (10301520)
- Ø 2 x 130 m (10313020)
- Ø 2,4 x 15 m (10301524)
- Ø 2,4 x 90 m (10309024)
- Ø 2,4 x 360 m (10336024)
- Ø 3 x 60 m (10306030)
- Ø 3 x 240 m (10324030)
- Ø 2,4 x 15 m (10401524)
- Ø 2,4 x 60 m (10406024)
- Ø 2,4 x 345 m (10434524)
- Ø 3 x 15 m (10401530)
- Ø 3 x 40 m (10404030)
- Ø 3 x 232 m (10423230)



www.hecht.cz

1. Insert

2. Get through

3. Reel in

4. Complete

EASY-load

Easy load system - really quick string change without using any tools.

Illustrative image

GREASE GX 100 ml

PLASTIC LUBRICANT FOR ANGLE DRIVES 100 ML

Min. order 10 pcs



HECHT 000102

SHOULDER STRAP



HECHT 000103

SHOULDER STRAP



HECHT 000104

SHOULDER STRAP



ACCU PROGRAM 6260 – 62 V



Patented wheel design



EDGE CUTTING
Ability of mowing at fence or wall



HECHT 6246 S LAWN MOWER

★★★★★

Replaces gasoline mowers in terms of performance



Patented wheel design



EDGE CUTTING
Ability of mowing at fence or wall



HECHT 6251 S LAWN MOWER

★★★★★

Replaces gasoline mowers in terms of performance



| | | | |
|---------------------|----------------|--------------------------------------|-----------|
| self-propelled | 3 km/h | working height | 25–75 mm |
| accu | DC 62 V | chassis | steel |
| Li-Ion | 1 × 2,5 / 4 Ah | collecting box | 60 l |
| working width | 46 cm | central adjustment of cutting height | |
| weight | 32 kg | charging time | ≤ 75 min. |
| Ø wheels front/back | 8/11" | working time | ≤ 58 min. |

| | | | |
|---------------------|----------------|--------------------------------------|-----------|
| self-propelled | 3 km/h | working height | 25–75 mm |
| accu | DC 62 V | chassis | steel |
| Li-Ion | 1 × 2,5 / 4 Ah | collecting box | 60 l |
| working width | 51 cm | central adjustment of cutting height | |
| weight | 33 kg | charging time | ≤ 75 min. |
| Ø wheels front/back | 8/11" | working time | ≤ 50 min. |

BATTERY 006225B DC 62 V, 2,5 Ah



BATTERY 006240B DC 62 V, 4 Ah



BATTERY 006280B DC 62 V, 8 Ah



5in1

5 products with 1 battery and charger

Li-Ion Powered

BATTERY CHARGER 006260

input 230 V/50 Hz
output DC 62 V, 4 A



ACCU program 6260



ECO FRIENDLY

HECHT 6210 BRUSHCUTTER

★★★★★



Replaces gasoline brushcutters in terms of performance

| | | | |
|----------------------|---------------------------|---------------|-----------|
| accu | Li-Ion | working width | 35,6 cm |
| voltage (V) | DC 62 V 1 × 2,5 / 4 Ah | charging time | ≤ 75 min. |
| no-load working time | 50 min | | |



Replaces gasoline chainsaws in terms of performance

| | | | |
|---------------|-----------------------------|-------------|-------------|
| accu Li-Ion | DC 62 V / 1 × 2,5 / 4 Ah | bar length | 40 cm / 16" |
| weight | 4,3 kg | chain type | 33E57E |
| charging time | ≤ 75 min. | chain speed | 20 m/s |

HECHT 6294 CHAINSAW

★★★★★

HECHT 6290 BLOWER

★★★★★



Replaces gasoline blowers in terms of performance

| | | | |
|---------------|-----------------------------|--------------|-------------|
| accu Li-Ion | DC 62 V / 1 × 2,5 / 4 Ah | air velocity | 55 m/s |
| weight | 2 kg | air volume | 18,5 m³/min |
| no-load speed | 28000 min ⁻¹ | working time | ≤ 102 min. |
| charging time | ≤ 75 min. | | |

All products from this accu program are delivered without charger and battery.

ELECTRIC & ACCU GRASS TRIMMERS

HECHT 5013

ACCU GRASS SHEAR & HEDGE TRIMMER



2 in 1

Working time
40 min.



Scissors



Hedge



| | | | | | |
|--|---------------|-------------------|--|---------------|----------|
| | Li-ion | DC 7,2 V / 1,3 Ah | | weight | 0,8 kg * |
| | working width | 7,5/16 cm | | charging time | cca 4 h |

HECHT 5036

ACCU GRASS SHEAR & HEDGE TRIMMER



Separable handle



To be used with or without handle, as ACCU shears or hedge trimmer

Working time
40 min.



Telescopic handle
103-179 cm

2 in 1

Scissors



Hedge



| | | | | | |
|--|-------------------------|-------------------|--|---------------|-----------|
| | Li-ion Samsung | DC 7,2 V / 1,3 Ah | | working width | 7,5/16 cm |
| | charging / working time | 4 h / 40 min | | weight | 2,2 kg |

HECHT 444

ELECTRIC WEED SWEEPER



Order no.
444000006



Order no.
444000043

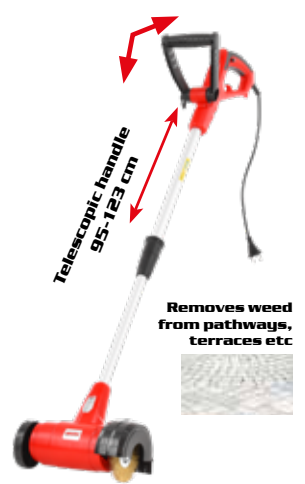

Removes weed from pathways, terraces etc

| | | | | | |
|--|-------------|-------------------|--|---------------|--------|
| | electric | DC 3,6 V / 1,3 Ah | | working width | 11 cm |
| | power input | 400 W | | weight | 2,2 kg |

Plastic and wire brush included

HECHT 445

ELECTRIC WEED SWEEPER



2 in 1

Included

For joints



2 pcs - order no.
HECHT 0004452

For larger areas



2 pcs - order no.
HECHT 000445



Twist grip

Telescopic handle
94-123 cm

Removes weed from pathways, terraces etc



| | | | | | |
|--|-------------|---------------|--|---------------|---------|
| | electric | 230 V / 50 Hz | | working width | 19,5 cm |
| | power input | 550 W | | weight | 2,9 kg |

HECHT 300

GRASS TRIMMER



Semiautomatic string head

CUTTING HEAD
HECHT 003003



| | | | | | |
|--|---------------------------|---------------|--|---------------|--------------|
| | electric | 230 V / 50 Hz | | working width | 22 cm |
| | power input | 300 W | | weight | 1,4 kg |
| | semiautomatic string head | | | spare spool | HECHT 003003 |

HECHT 530

GRASS TRIMMER



Twist grip

Semiautomatic string head

Adjustable angle

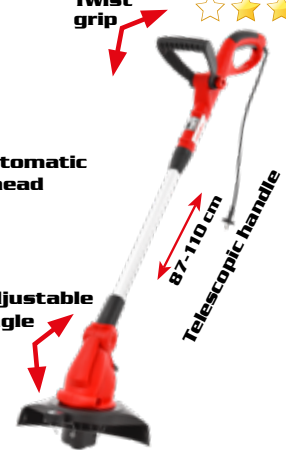

Telescopic handle
87-110 cm

| | | | | | |
|--|---------------------------|---------------|--|---------------|-------------------|
| | electric | 230 V / 50 Hz | | working width | 30 cm |
| | power input | 550 W | | weight | 2,6 kg |
| | semiautomatic string head | | | spare spool | 530000043 (2 pcs) |

HECHT 630

GRASS TRIMMER



Twist grip

Telescopic handle
90-105 cm

Adjustable angle

Semiautomatic string head

| | | | | | |
|--|---------------------------|---------------|--|---------------|----------------|
| | electric | 230 V / 50 Hz | | working width | 30 cm |
| | power input | 600 W | | weight | 2,8 kg |
| | semiautomatic string head | | | spare spool | 000630 (2 pcs) |

HECHT 5020

ACCU GRASS TRIMMER

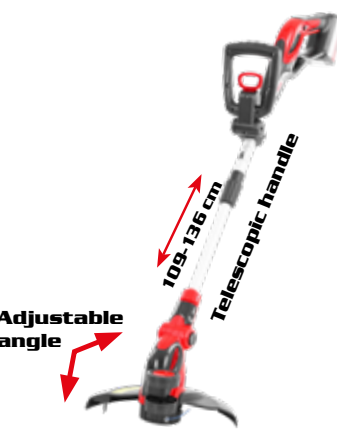

Adjustable angle

Telescopic handle
109-136 cm



| | | | | | |
|--|--------------|----------------------|--|---------------------|-------------|
| | Accu Li-ion | DC 20 V / 1 x 2,5 Ah | | working width | 25 cm |
| | working time | cca 20 min | | weight with battery | 2,2 kg |
| | spare spool | 005020 (2 ks) | | charging time | cca 120 min |

HECHT 5022

ACCU GRASS TRIMMER



502200033
Spare plastic blades 20 ks



Adjustable angle



Telescopic handle
110-139 cm

Available from 3/25



| | | | | | |
|--|----------------------|-------------------------|--|---------------------|------------|
| | Accu Li-ion | DC 20 V, 1 x 214/6/8 Ah | | working width | 25,4 cm |
| | working time | cca 60 min * | | weight with battery | 1,9 kg |
| | spare plastic blades | 502200033 | | charging time | cca 60 min |

www.hecht.cz

ELECTRIC & ACCU GRASS TRIMMERS, BRUSHCUTTERS



HECHT 1040 ACCU GRASS TRIMMER



Battery and charger not included



| | | | | | |
|--|---------------------------|--------------------------|--|---------------|-------------|
| | accumulator | Li-ion | | working width | 28-32 cm |
| | accu article (V) | DC 40 V 1x 2,5/4/5 Ah | | weight | 3,8 kg |
| | working time without load | cca 40 min | | charging time | cca 120 min |



HECHT 1435 ACCU BRUSHCUTTER



Basic accessories includes: string cutting head and metal blade, shoulder belt



CUTTING HEAD



CUTTING BLADE



Available from 2/25

| | | | | | |
|--|---------------------------|------------------------------|--|-----------------------------------|--------------|
| | accumulator | Li-ion | | working width blade / string head | 25,5 / 35 cm |
| | accu article (V) | DC 20+20 V, 2x 2/4/6/8 Ah | | weight | 4,3 kg |
| | working time without load | cca 30 min | | charging time | cca 60 min * |



HECHT 6210 ACCU GRASS TRIMMER



| | | | | | |
|--|---------------------------|--------------------------|--|---------------|-----------|
| | accumulator | Li-ion | | working width | 35,6 cm |
| | accu article (V) | DC 62 V 1x 2,5 / 4 Ah | | weight | 3,1 kg |
| | working time without load | 50 min * | | charging time | ≤ 75 min. |



HECHT 1440 ACCU BRUSHCUTTER



Battery and charger not included

Basic accessories includes: string cutting head and metal blade, shoulder belt

Removable handle



CUTTING HEAD
HECHT 000109



| | | | | | |
|--|---------------------------|--------------------------|--|-----------------------------------|--------------|
| | accumulator | Li-ion | | working width blade / string head | 25,4 / 30 cm |
| | accu article (V) | DC 40 V 1x 2,5/4/5 Ah | | charging time | cca 120 min |
| | working time without load | 40-55 min | | weight | 5,5 kg |



Separable shaft

HECHT 1299 ELECTRIC GRASS TRIMMER



CUTTING HEAD

1299010361



| | | | | | |
|--|---------------|-------------|--|---------------|------------|
| | electric | 230 V/50 Hz | | working width | 38 cm |
| | power input | 1400 W | | weight | 4,8 kg |
| | shoulder belt | | | cutting head | 1299010361 |

Separable shaft



Removable handle

HECHT 1445 ELECTRIC BRUSHCUTTER



CUTTING BLADE

600250



CUTTING HEAD

13602060



| | | | | | |
|--|------------------|-------------|--|------------------------------|--------------|
| | electric | 230 V/50 Hz | | working width - blade / head | 25,4 / 42 cm |
| | power input | 1400 W | | weight | 5 kg |
| | removable handle | | | cutting blade | 600250 |
| | cutting head | 13602060 | | shoulder belt | |

PETROL GRASS TRIMMERS, BRUSHCUTTERS



Separable shaft

HECHT 124 R

PETROL GRASS TRIMMER



NEW



Separable shaft

HECHT 126 R

PETROL GRASS TRIMMER



CUTTING HEAD
124R00004

Crankshaft mounted on both sides

| | | | | | |
|---|---------------|----------------------|---|---------------|-----------|
| | engine volume | 25,4 cm ³ | | weight | 5,1 kg |
| | power output | 0,75 kW | | working width | 38 cm |
| ✓ | shoulder belt | | ✓ | cutting head | 124R00004 |

| | | | | | |
|---|---------------|----------------------|---|---------------|-----------|
| | engine volume | 25,4 cm ³ | | weight | 5,1 kg |
| | power output | 0,9 HP | | working width | 40 cm |
| ✓ | shoulder belt | | ✓ | cutting head | 124R00004 |



CUTTING BLADE
600250



CUTTING HEAD
HECHT 000109

HECHT 129 BTS

PETROL BRUSHCUTTER



Separable shaft

HECHT 135 BTS

PETROL BRUSHCUTTER



| | | | | | |
|---|---------------|----------------------|---|-----------------------------------|--------------|
| | engine volume | 25,4 cm ³ | | working width - blade / head | 25,5 / 43 cm |
| | power output | 1 HP | | weight | 6,1 kg |
| ✓ | shoulder belt | | ✓ | cutting blade | 600250 |
| ✓ | cutting head | HECHT 000109 | ✓ | removable handle, separable shaft | |

| | | | | | |
|---|---------------|--------------------|---|-----------------------------------|--------------|
| | engine volume | 33 cm ³ | | working width - blade / head | 25,5 / 43 cm |
| | power output | 1,5 HP | | weight | 6,1 kg |
| ✓ | shoulder belt | | ✓ | cutting blade | |
| ✓ | cutting head | HECHT 000109 | ✓ | removable handle, separable shaft | |

Separable shaft



CUTTING HEAD
HECHT 000109

HECHT 142 BTS

PETROL BRUSHCUTTER



Separable shaft

HECHT 152 BTS

PETROL BRUSHCUTTER



CUTTING HEAD
HECHT 000129

| | | | | | |
|---|---------------|--------------------|---|------------------------------|--------------|
| | engine volume | 43 cm ³ | | working width - blade / head | 25,5 / 43 cm |
| | power output | 2 HP | | weight | 7,45 kg |
| ✓ | shoulder belt | | ✓ | cutting blade | |
| ✓ | cutting head | HECHT 000109 | ✓ | separable shaft | |

| | | | | | |
|---|---------------|--------------------|---|-----------------------------------|--------------|
| | engine volume | 52 cm ³ | | working width - blade / head | 25,5 / 43 cm |
| | power output | 2,2 HP | | weight | 7,9 kg |
| ✓ | shoulder belt | | ✓ | cutting blade | |
| ✓ | cutting head | HECHT 000129 | ✓ | removable handle, separable shaft | |

PETROL BRUSHCUTTERS

HECHT 145

PETROL BRUSHCUTTER



CUTTING HEAD
HECHT 000129



CUTTING HEAD
HECHT 000109



CUTTING BLADE
600250

HECHT 143 R

PETROL BRUSHCUTTER



| | | | | | |
|---|---------------|--------------------|---|------------------------------|--------------|
| | engine volume | 43 cm ³ | | working width - blade / head | 25,5 / 43 cm |
| | power output | 2 HP | | weight | 7,9 kg |
| ✓ | shoulder belt | | ✓ | cutting blade | |
| ✓ | cutting head | HECHT 000129 | | | |

| | | | | | |
|---|---------------|----------------------|---|------------------------------|--------------|
| | engine volume | 42,5 cm ³ | | working width - blade / head | 25,5 / 43 cm |
| | power output | 1,6 HP | | weight | 6,1 kg |
| ✓ | shoulder belt | | ✓ | cutting blade | 600250 |
| ✓ | cutting head | HECHT 000109 | | | |

HECHT 150

PETROL BRUSHCUTTER



CUTTING HEAD
16300000H

Carburetor WALBRO

Easy start

Self-locking shaft lock



HECHT 154

PETROL BRUSHCUTTER



CUTTING HEAD
HECHT 000129

| | | | | | |
|---|---------------|----------------------|---|------------------------------|------------|
| | engine volume | 51,7 cm ³ | | working width - blade / head | 30 / 43 cm |
| | power output | 2 HP | | weight | 10 kg |
| ✓ | shoulder belt | | ✓ | cutting blade | |
| ✓ | cutting head | 16300000H | | | |

| | | | | | |
|---|---------------|--------------------|---|------------------------------|--------------|
| | engine volume | 52 cm ³ | | working width - blade / head | 25,5 / 43 cm |
| | power output | 2,6 HP | | weight | 8,7 kg |
| ✓ | shoulder belt | | ✓ | cutting blade | |
| ✓ | cutting head | HECHT 000129 | ✓ | Autochoke | |

A robust cleaning brush cutter for demanding applications

HECHT 163

PROFI PETROL BRUSHCUTTER



CUTTING HEAD
16300000H

3,1 HP

NEW

HECHT 1352

MULTIFUNCTION BRUSHCUTTER



4in1

| | | | | | |
|---|---------------|----------------------|---|------------------------------|------------|
| | engine volume | 63,3 cm ³ | | working width - blade / head | 30 / 43 cm |
| | power output | 3,1 HP | | weight | 10,8 kg |
| ✓ | shoulder belt | | ✓ | cutting blade | |
| ✓ | cutting head | 16300000H | | | |

| | | | | | |
|---|---------------|----------------------|--|------------------------------|--------------|
| | engine volume | 51,7 cm ³ | | working width - blade / head | 25,5 / 43 cm |
| | power output | 2 HP | | saw blade bar length | 25 cm |
| ✓ | shoulder belt | | | hedge trimmer bar length | 42,5 cm |
| ✓ | extension rod | | | weight | 5,6 kg |

PETROL BRUSHCUTTER, SNOW SHOVELS

HECHT 155 PETROL BRUSHCUTTER



Fixed shaft mounting - no stress on the motor silentblock (better vibration suspension for the operator).

2-stroke



HECHT 000155 ADDITIONAL SWEEPING ROLLER for HECHT 155

(not included)



Rotary base 45°

| | | | | | |
|--|---------------|--------------------|--|---------------|---------|
| | engine volume | 52 cm ³ | | working width | 45,5 cm |
| | power output | 2 HP | | weight | 15 kg |

www.hecht.cz

HECHT 280 GT

Snow shovel for children, stroke 28 cm.



HECHT 205 GT

Folding shovel, aluminum tube shaft, stroke 20,5 cm.



SUITABLE FOR CAR

HECHT 275 GT

PP D – grip. Plastic handle reinforced by steel pipe, stroke 27 cm.



HECHT 180 GT

Stainless steel ice scraper, foam handle, blade thickness 3 mm, stroke 18 cm, weight 1,3 kg.



HECHT 460 GT

PP D – grip. Plastic handle reinforced by steel pipe, stroke 46 cm.



SNOW SHOES

Covers the common shoes in sizes S, M, L with metal antislip tips.



| size | |
|------|-------|
| S | 35–38 |
| M | 39–42 |
| L | 42–46 |

HECHT 505 GT

PP D – grip. Plastic handle reinforced by steel pipe, stroke 50 cm.



HECHT 5400 GT

PP D – grip. Plastic handle reinforced by steel pipe, stroke 54 cm.



HECHT 465 AL

Plastic grip with aluminium handle, stroke 46 cm.



HECHT 750 GT

Metal bar, wheels, stroke 75 cm.

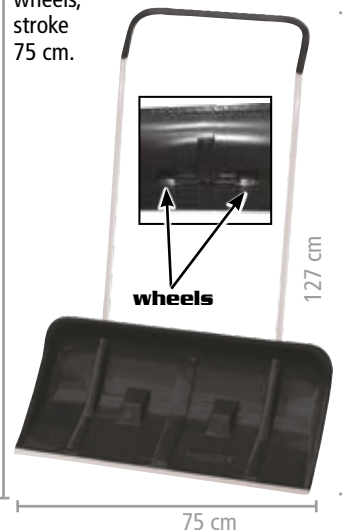

HECHT 661 GT

Snow scraper with wheels, metal bar and loose handle, stroke 66 cm.



ELECTRIC AND ACCU SNOWTHROWERS

HECHT 9200

SINGLE-STAGE
ELECTRIC THROWER



50 cm

HECHT 9235

SINGLE-STAGE
ELECTRIC THROWER



50 cm

HECHT 9201 E

SINGLE-STAGE
ELECTRIC THROWER



94 cm

51 cm

| | | | | | | | | | | | |
|-------------------------|---------------|-----------------|---------|-------------------------|---------------|--------------------------|---------|-------------------------|---------------|-----------------|----------|
| ⚡ electric | 230 V / 50 Hz | 📏 stroke height | 25 cm | ⚡ electric | 230 V / 50 Hz | 📏 max. throwing distance | 9 m | ⚡ electric | 230 V / 50 Hz | 📏 clean up area | 250 m³/h |
| 🔌 power input | 2000 W | 📏 weight | 13,1 kg | 🔌 power input | 2300 W | 📏 weight | 13,3 kg | 🔌 power input | 2000 W | 📏 weight | 17 kg |
| 📏 working / total width | 40/50 cm | 👉 pushed | | 📏 working / total width | 50/25 cm | 👉 pushed | | 📏 working / total width | 43/51 cm | 👉 pushed | |

HECHT 9040

SINGLE-STAGE
ACCU THROWER

ACCU
program
5040

Li-ion
Powered

ECO
FRIENDLY



90 cm

46 cm

Battery and
charger not
included

HECHT 9555

DOUBLE-STAGE SELF PROPELLED
PETROL THROWER

4-stroke

Sheet metal
chimney

Propel:
4 gears forward
1 gear reverse



88 cm

56 cm

Gliders*

| | | | | | | | |
|-------------------------|----------------|-----------------|---------|-----------------|--------------|--------------------------|-------|
| ⚡ accu Li-ion | DC 40 V / 4 Ah | 📏 stroke width | 46 cm | 🔧 engine HECHT | 4-stroke OHV | 📏 max. throwing distance | 11 m |
| 🌀 no load speed | 2600 / min. | 📏 stroke height | 27 cm | 📏 displacement | 196 cm³ | 📏 adjustable chimney by | 190 ° |
| 📏 adjustable chimney by | 190 ° | 📏 weight | 19,5 kg | 📏 stroke width | 56 cm | 📏 wheels | 12" |
| | | | | 📏 stroke height | 40 cm | 📏 weight | 55 kg |

HECHT 9555 SE

DOUBLE-STAGE SELF PROPELLED
PETROL THROWER

230 V/50 Hz
electric starter

Sheet metal
chimney

Propel:
4 gears forward
1 gear reverse



88 cm

56 cm

Gliders*

HECHT 9661

DOUBLE-STAGE SELF PROPELLED
PETROL THROWER

Adjustable chimney
by 190 °

Propel:
6 gears forward
2 reverse gears

Airless wheels

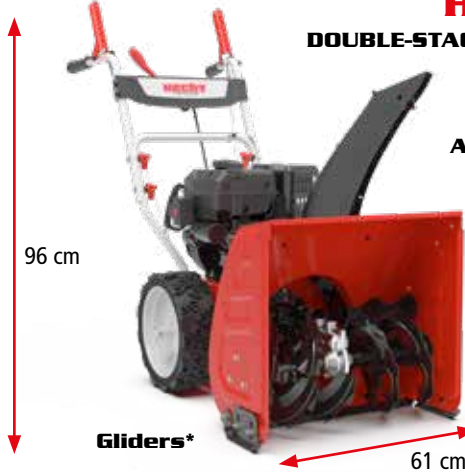

96 cm

61 cm

Gliders*

| | | | | | | | |
|-----------------|--------------|--------------------------|-------|-----------------|--------------|--------------------------|-----------|
| 🔧 engine HECHT | 4-stroke OHV | 📏 max. throwing distance | 11 m | 🔧 engine HECHT | 4-stroke OHV | 📏 max. throwing distance | 13 m |
| 📏 displacement | 196 cm³ | 📏 adjustable chimney by | 190 ° | 📏 displacement | 196 cm³ | 📏 adjustable chimney by | 190 ° |
| 📏 stroke width | 56 cm | 📏 wheels | 12" | 📏 stroke width | 61 cm | 📏 wheels | 13x4,1-6" |
| 📏 stroke height | 40 cm | 📏 weight | 56 kg | 📏 stroke height | 53 cm | 📏 weight | 80,3 kg |

* Gliders - serve to protect the surface, improve movement and maneuvering, extend the life of the thrower and reduce resistance during movement.

PETROL SNOWTHROWERS



HECHT 9661 SE

DOUBLE-STAGE SELF PROPELLED PETROL THROWER

230 V/50 Hz electric starter

Adjustable chimney by 190°

Propel: 6 gears forward 2 reverse gears

Airless wheels

| | | | | | |
|--|---------------|---------------------|--|------------------------|------------|
| | engine HECHT | 4-stroke OHV | | max. throwing distance | 13 m |
| | displacement | 196 cm ³ | | adjustable chimney by | 190° |
| | stroke width | 61 cm | | wheels | 15x5.00-6" |
| | stroke height | 53 cm | | weight | 88 kg |



HECHT 9666

DOUBLE-STAGE SELF PROPELLED PETROL THROWER

230 V/50 Hz electric starter

Heated handles

Propel: 6 gears forward 2 reverse gears

| | | | | | |
|--|---------------|---------------------|--|------------------------|--------|
| | engine HECHT | 4-stroke OHV | | max. throwing distance | > 15 m |
| | displacement | 252 cm ³ | | adjustable chimney by | 190° |
| | stroke width | 66 cm | | weight | 110 kg |
| | stroke height | 54 cm | | | |

www.hecht.cz



HECHT 9334 SQ

DOUBLE-STAGE SELF PROPELLED PETROL THROWER

Propel: 6 gears forward 2 reverse gears

230 V/50 Hz electric starter

Heated handles

Airless wheels

| | | | | | |
|--|---------------|---------------------|--|------------------------|-----------|
| | engine HECHT | 4-stroke OHV | | max. throwing distance | 15 m |
| | displacement | 375 cm ³ | | adjustable chimney by | 190° |
| | stroke width | 87 cm | | wheels | 16x6,5-6" |
| | stroke height | 51 cm | | weight | 127 kg |



HECHT 9542 SQ

DOUBLE-STAGE SELF PROPELLED PETROL THROWER

230 V/50 Hz electric starter

Airless wheels



| | | | | | |
|--|---------------|---------------------|--|------------------------|-----------|
| | engine HECHT | 4-stroke OHV | | max. throwing distance | 15 m |
| | displacement | 420 cm ³ | | adjustable chimney by | 190° |
| | stroke width | 106 cm | | wheels | 16x6,5-8" |
| | stroke height | 51 cm | | weight | 143,6 kg |



HECHT 9534 SQ

DOUBLE-STAGE SELF PROPELLED PETROL THROWER

230 V/50 Hz electric starter

Heated handles

Height adjustment during work and transport

Propel: 6 gears forward 2 reverse gears

| | | | | | |
|--|---------------|---------------------|--|------------------------|--------|
| | engine HECHT | 4-stroke OHV | | max. throwing distance | 15 m |
| | displacement | 420 cm ³ | | adjustable chimney by | 180° |
| | stroke width | 87 cm | | weight | 146 kg |
| | stroke height | 51 cm | | | |



HECHT 9942 SQ

DOUBLE-STAGE STAND-ON PETROL THROWER

Electric start 230 V/50 Hz

Hydrostatic transmission

2x LED light

Electronic functions control

| | | | | | |
|--|---------------|---------------------|--|------------------------|--------|
| | engine HECHT | 4-stroke OHV | | max. throwing distance | 15 m |
| | displacement | 420 cm ³ | | adjustable chimney by | 190° |
| | stroke width | 108 cm | | weight | 250 kg |
| | stroke height | 54 cm | | stand-on operation | |

SWEEPERS, ACCESSORIES

HECHT 8065 MECHANICAL SWEEPER

☆☆☆☆☆

Ideal for paved outdoor areas, captures both wet and dry material



112 cm

69 cm

65 cm

80650004
ONE PAIR OF SPARE DISC BRUSHES

| | | | | |
|--|------------------|--|---------------|--------|
| | pushed | | working width | 65 cm |
| | debris collector | | weight | 9,6 kg |
| | 20 l | | | |

HECHT 8105 MECHANICAL SWEEPER

NEW

Adjustable pressure of front brushes

Adjustable rare roller brush

Ideal for paved outdoor areas, captures both wet and dry material



130 cm

103,5 cm

105 cm

Available from 4/25

| | | | | |
|--|------------------|--|---------------|--------|
| | pushed | | working width | 105 cm |
| | debris collector | | weight | 24 kg |
| | 48 l | | | |

HECHT 8615 PETROL SWEEPER

☆☆☆☆☆

3 in 1



34,5 cm

60 cm

Available from 2/25

| | | | | | |
|--|---------------|---------------------|--|--------------------------------|-------------|
| | engine HECHT | 4-stroke OHV | | weight | 69 kg |
| | displacement | 196 cm ³ | | 5 gear forward, 2 gear reverse | |
| | max. torque | 12,4 Nm | | sweeper speed | 250 rpm |
| | working width | 55/61/62 cm | | wheels | 13 x 4,1-6" |

HECHT 8616 SE PETROL SWEEPER

☆☆☆☆☆

With 230 V electric starter and adjustable light

4 in 1

LED light



96 cm

35 cm

62 cm

| | | | | | |
|--|---------------|---------------------|--|--------------------------------|-------------|
| | engine HECHT | 4-stroke OHV | | weight | 69 kg |
| | displacement | 196 cm ³ | | 4 gear forward, 2 gear reverse | |
| | max. torque | 12,5 Nm | | sweeper speed | 570 rpm |
| | working width | 55/61/62 cm | | wheels | 13 x 4,1-6" |

Accessories for HECHT 8615 / 8616 / 8616 E / 8616 SE / 8680 SE

PLOUGHSHARE 61 CM
000861 A
for HECHT 8616, 8616 E, 8616 SE

PLOUGHSHARE 61 CM
0008680 A
for HECHT 8680 SE

SNOW THROWER
000861 C
for HECHT 8616, 8616 E, 8616 SE, 8680 SE

Available from 2/25

PLUGHSHARE
0008615 A
for HECHT 8615

13" CHAINS
009551



COLLECTING BOX 61 CM
000861 B
for HECHT 8616, 8616 E, 8616 SE

COLLECTING BOX 80 CM
0008680 B
for HECHT 8680 SE



PLUGHSHARE
0008615 B
for HECHT 8615

COLLECTING BOX 60 CM
0008615 B
for HECHT 8615



Accessories for HECHT 8101 / 8101 S / 8101 BS

PLUGHSHARE
0008101 A
for HECHT 8101, 8101 S, 8101 BS

COLLECTING BOX 61 CM
0008101 B
for HECHT 8101, 8101 S, 8101 BS

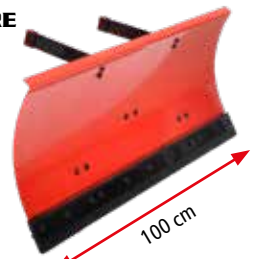

SWEEPERS, SPREADERS

HECHT 8680 SE PETROL SWEEPER



4 in 1



| | | | | | |
|--|---------------|---------------------|--|--------------------------------|-------------|
| | engine HECHT | 4stroke OHV | | weight | 80 kg |
| | displacement | 196 cm ³ | | 4 gear forward, 2 gear reverse | |
| | max. torque | 12,5 Nm | | sweeper speed | 570 rpm |
| | working width | 80 cm | | wheels | 13 x 4,1-6" |

HECHT 8101 PETROL SWEEPER



Variable brush speed



| | | | | | |
|--|---------------|---------------------|--|--------------------------------|---------------|
| | engine HECHT | 4-stroke OHV | | weight | 79 kg |
| | displacement | 196 cm ³ | | 3 gear forward, 1 gear reverse | |
| | max. torque | 10,5 Nm | | sweeper speed | 180 - 350 rpm |
| | working width | 100/100 cm | | wheels | 13 x 4,1-6" |

HECHT 8101 S PETROL SWEEPER



Variable brush speed



| | | | | | |
|--|---------------|---------------------|--|--------------------------------|---------------|
| | engine HECHT | 4-stroke OHV | | weight | 82 kg |
| | displacement | 196 cm ³ | | 3 gear forward, 1 gear reverse | |
| | max. torque | 10,5 Nm | | sweeper speed | 180 - 350 rpm |
| | working width | 100/100 cm | | wheels | 13 x 4,1-6" |

HECHT 8101 BS PETROL SWEEPER



Variable brush speed



| | | | | | |
|--|---------------------|---------------------|--|--------------------------------|---------------|
| | 4-stroke engine B&S | 750 EX | | weight | 76 kg |
| | displacement | 161 cm ³ | | 3 gear forward, 1 gear reverse | |
| | max. torque | 9,5 Nm | | sweeper speed | 180 - 350 rpm |
| | working width | 100/100 cm | | wheels | 13 x 4,1-6" |

HECHT 33

HAND SPREADER FOR DISTRIBUTION OF FERTILIZERS, SEEDS OR SALT



| | | | | |
|--|--------|--------|--------------|-------------------------|
| | manual | | max capacity | cca 3 l |
| | weight | 0,5 kg | | max. width of spreading |
| | | | | 2 m* |

HECHT 212

HAND SPREADER FOR DISTRIBUTION OF FERTILIZERS, SEEDS OR SALT



| | | | | |
|--|-----------------|------|--------------|-------------------------|
| | manually pushed | | max capacity | 12 l |
| | weight | 2 kg | | max. width of spreading |
| | | | | 45 cm* |

HECHT 220

HAND SPREADER FOR DISTRIBUTION OF FERTILIZERS, SEEDS OR SALT



| | | | | |
|--|-----------------|--------|--------------|-------------------------|
| | manually pushed | | max capacity | 20 l |
| | weight | 2,9 kg | | max. width of spreading |
| | | | | 48 cm* |

* The spreading width depends mainly on the speed / movement and the type of spreading material.

SPREADERS, COMPOSTERS

HECHT 270

HAND SPREADER FOR DISTRIBUTION OF FERTILIZERS, SEEDS OR SALT

Cover sheet included



Spreading regulation



Cover sheet included

| | | | | |
|--|---------------|--------|-------------------------|------|
| | manual pushed | | max capacity | 27 l |
| | weight | 4,4 kg | max. width of spreading | 3 m* |
| | wheels | 9x3" | | |

HECHT 229

HAND SPREADER FOR DISTRIBUTION OF FERTILIZERS, SEEDS OR SALT

Spreading regulation

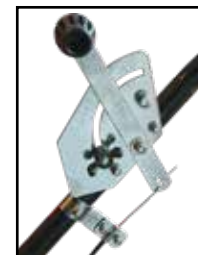

| | | | | |
|--|---------------|-------|-------------------------|--------------|
| | manual pushed | | max. volume / capacity | 29 l / 36 kg |
| | weight | 11 kg | max. width of spreading | 3 m* |
| | wheels | 12x3" | | |

HECHT 256

HAND SPREADER FOR DISTRIBUTION OF FERTILIZERS, SEEDS OR SALT

Cover sheet included



Spreading regulation



| | | | | |
|--|---------------|------------|-------------------------|--------------|
| | manual pushed | | max capacity | 60 l / 56 kg |
| | weight | 17,3 kg | max. width of spreading | 3,5 m* |
| | wheels | 15x6.00-6" | | |

HECHT 260

TOW-BEHIND SPREADER

For large areas of ground for distribution of fertilizers, seeds or salt

Cover sheet included

Spreading regulation



Suitable for lawn tractors



| | | | | |
|--|---------------|---------|-------------------------|--------------|
| | manual pushed | | max capacity | 60 l / 56 kg |
| | weight | 12,6 kg | max. width of spreading | 4 m* |
| | wheels | 12x3" | | |

HECHT 3060

GARDEN COMPOSTER

Composter for garden and kitchen biological waste, grass, leaves.

Ideal to prepare quality compost.

Easy assembly

Made of durable plastic



HECHT 6600

GARDEN COMPOSTER

Composter for garden and kitchen biological waste, grass, leaves.

Ideal to prepare quality compost.

Easy assembly

Made of durable plastic



HECHT 2600

EXTENSION KIT FOR COMPOSTER HECHT 6600



| | | |
|--|---------------|--------------------|
| | max. capacity | 360 l |
| | dimensions | 689 x 689 x 839 mm |

| | | |
|--|---------------|--------------------|
| | max. capacity | 600 l |
| | dimensions | 933 x 933 x 805 mm |

| | | |
|--|---------------|--------------------|
| | max. capacity | 260 l |
| | dimensions | 933 x 933 x 370 mm |

* The spreading width depends mainly on the speed / movement and the type of spreading material.

GARDEN TOOLS

420 CC



| | |
|------------------|--------|
| length | 215 mm |
| cutting diameter | 20 mm |
| blade material | S50C |

421



| | |
|------------------|--------|
| length | 215 mm |
| cutting diameter | 20 mm |
| blade material | SK5 |

493 A



| | |
|------------------|--------|
| length | 215 mm |
| cutting diameter | 20 mm |
| blade material | SK5 |

435 HB 2L



| | |
|------------------|--------|
| length | 225 mm |
| cutting diameter | 20 mm |
| blade material | SK5 |

434DLA08



| | |
|------------------|--------|
| length | 200 mm |
| cutting diameter | 20 mm |
| blade material | SK5 |

494 ADN



| | |
|------------------|--------|
| length | 213 mm |
| cutting diameter | 20 mm |
| blade material | SK5 |

023-2W



| | |
|------------------|--------|
| length | 500 mm |
| cutting diameter | - |
| blade material | S50C |

018KB



| | |
|------------------|--------|
| length | 710 mm |
| cutting diameter | 35 mm |
| blade material | S50C |

020 AKB



| | |
|------------------|--------|
| length | 710 mm |
| cutting diameter | 38 mm |
| blade material | S50C |

018 LGG

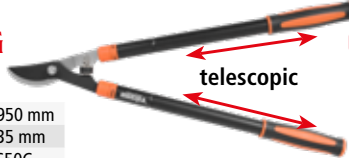

| | |
|------------------|--------|
| length | 950 mm |
| cutting diameter | 35 mm |
| blade material | S50C |

020 ALGG

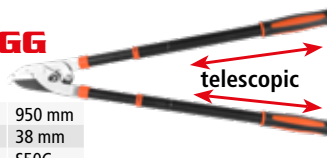

| | |
|------------------|--------|
| length | 950 mm |
| cutting diameter | 38 mm |
| blade material | S50C |

036 WL6



| | |
|------------------|--------|
| length | 835 mm |
| cutting diameter | - |
| blade material | S50C |

0182036L



| | |
|------------------|--------|
| length | 870 mm |
| cutting diameter | 38 mm |
| blade material | SK5 |

060AH9L



| | |
|------------------|--------|
| length | 875 mm |
| cutting diameter | - |
| blade material | SK5 |

050TAH9L



| | |
|------------------|---------|
| length | 1040 mm |
| cutting diameter | 45 mm |
| blade material | SK5 |

050GAH9L

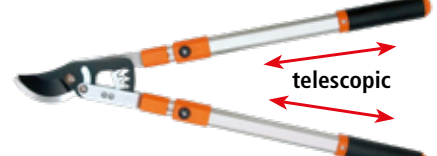

| | |
|------------------|---------|
| length | 1040 mm |
| cutting diameter | 45 mm |
| blade material | SK5 |

www.hecht.cz

HECHT 1740

ACCU GARDEN SCISSORS

| | |
|------------------|------------------------------|
| accu Li-ion | DC 20 V, 1x 2 / 4 / 6 / 8 Ah |
| cutting diameter | 30 mm |



Blade material

| | |
|------|-----------------------|
| SK5 | Japanese carbon steel |
| S50C | Carbon steel |

HECHT 600635

GARDEN KNIFE 35 CM WITH GUT HOOK, NYLON SHEATH, BLADE 19 CM



ACCU program 1278

HECHT 99126

ACCU SHEARS AND CHAIN SAW (Not intended for DE)

Transport bag & spare chain included

| | |
|---------------|--------|
| accu Li-ion | 14,4 V |
| průměr střihu | 30 mm |
| bar lenght | 16 cm |

NEW



More info on page 34

F2AD

Folding saw



foldable

HECHT 900813

Length 13"



Belt hinge with sheath

HECHT 901018

Length 18"



HECHT 600636

MACHETE 64 CM, BLADE 44 CM WITH SAW, NYLON SHEATH, STAINLESS STEEL



HECHT 600618

Length 18"

HECHT 600621

Length 21"



GARDEN TOOLS, RAKES

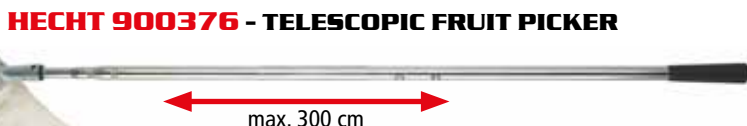

4in 1
(4 blades with 1 handle)
You can buy one handle
HECHT 600101 and then
buy the rake blades
individually.

HECHT 600101
OVAL ALUMINUM HANDLE
WITH PLASTIC SLEEVE,
SOFT GRIP AND END HOOK

HECHT 600123

PET rake blade 23 teeth
size 480 x 260 mm

Box: 12 pcs

HECHT 600112

Nylon rake blade 12 teeth
size 410 mm

Box: 6 pcs

HECHT 600135

PET rake blade 35 teeth
size 760 x 310 mm

Box: 12 pcs

HECHT 600118

Nylon rake blade 18 teeth
size 580 mm

Box: 6 pcs

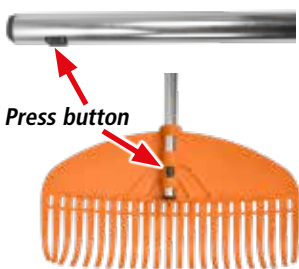

161 cm

HAND AND KNAPSACK SPRAYERS

HECHT 401 HAND SPRAYER



| | | |
|--------|------------------|-------|
| manual | container volume | 0,9 l |
|--------|------------------|-------|

HECHT 415 V HAND SPRAYER



Adjustable spraying jet

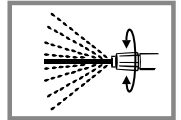

Pressure relief valve



| | | | |
|------------------|-------|--------|--------|
| manual | | weight | 0,5 kg |
| max. pressure | 2 bar | piston | |
| container volume | 1,5 l | | |

HECHT 405 HAND SPRAYER

Adjustable spraying jet

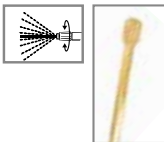

Shoulder strap included



| | | | |
|------------------|-------|-----------------------------|--------|
| manual | | weight | 1,3 kg |
| max. pressure | 3 bar | piston | |
| container volume | 5 l | telescopic pole max. length | 150 cm |

Adjustable spraying jet

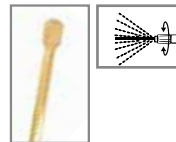

Shoulder strap included



Pressure relief valve

| | | | |
|------------------|-------|-----------------------------|--------|
| manual | | weight | 1,4 kg |
| max. pressure | 3 bar | piston | |
| container volume | 8 l | telescopic pole max. length | 150 cm |

HECHT 4500 HAND SPRAYER

Adjustable spraying jet

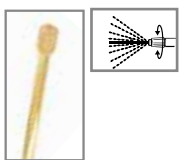

Shoulder strap included



Manometer



Pressure relief valve

| | | | |
|------------------|-------|-----------------------------|--------|
| manual | | weight | 1,4 kg |
| max. pressure | 3 bar | piston | |
| container volume | 5 l | telescopic pole max. length | 150 cm |

HECHT 4122 KNAPSACK SPRAYER

Shoulder strap included



| | | | |
|------------------|-------|----------------------|--------|
| manual | | weight | 2,8 kg |
| max. pressure | 4 bar | piston | |
| container volume | 12 l | spraying pole length | 58 cm |

HAND AND ACCU KNAPSACK SPRAYERS



HECHT 4166
KNAPSACK SPRAYER



Shoulder strap included



Charging indicator

Shoulder strap included

| | | | | | |
|--|------------------|-------|--|----------------------|--------|
| | manual | | | weight | 3,1 kg |
| | max. pressure | 4 bar | | piston | |
| | container volume | 16 l | | spraying pole length | 71 cm |



HECHT 4005
ACCU HAND SPRAYER

Battery included

telescopic -
60 cm



Charging indicator

Shoulder strap included

| | | | | | |
|--|---------------------------|--------------|--|----------------------|-------------|
| | accu Li-ion | 5 V / 2,5 Ah | | container volume | 5 l |
| | max. pressure | 2 bar | | water flow | 0,3 l/min |
| | working time without load | cca 2 h | | weight | 1,1 kg |
| | charging time | cca 4 h | | spraying pole length | up to 60 cm |

NEW



HECHT 4050
ACCU KNAPSACK SPRAYER

Battery included

Charging indicator

Shoulder straps included

Available from 4/25



2,5 bar



telescopic -
up to 60 cm

| | | | | | |
|--|---------------------------|--------------|--|----------------------|-------------|
| | accu Li-ion | 5 V / 2,5 Ah | | container volume | 5 l |
| | max. pressure | 2,5 bar | | water flow | 0,5 l/min |
| | working time without load | cca 2 h | | weight | 1 kg |
| | charging time | cca 3-6 h | | spraying pole length | up to 60 cm |



HECHT 9410
ACCU KNAPSACK SPRAYER

Battery and charger not included



| | | | | | |
|--|---------------------------|------------------------------|--|----------------------|---------|
| | accu Li-ion | DC 20 V, 1x 2 / 4 / 6 / 8 Ah | | container volume | 10 l |
| | max. pressure | 3 bar | | water flow | 1 l/min |
| | working time without load | cca 2 h | | weight | 4,9 kg |
| | charging time | 60 min. | | spraying pole length | 60 cm |

ACCESSORIES

| | | |
|-----|------------------------|---|
| 1. | 003016 | 30-75 cm telescopic rod with a flexible nozzle for HECHT 405, 408, 4500 |
| 2. | 000408 | the ability to connect multiple units in a row 38 cm for HECHT 405, 408, 4500 |
| 3. | 004500 | telescopic rod max 150 cm for HECHT 405, 408, 4500 |
| 4. | 000416 | telescopic rod max 150 cm for HECHT 425, 4120 |
| 5. | 000400 | gloss applicator for HECHT 405, 408, 4500 |
| 6. | 004112 | set of nozzles for HECHT 4112, 4116 |
| 7. | HECHT 00415A ** | nozzle „F-type“ for HECHT 416 ACCU |
| 8. | 000410 | telescopic rod for HECHT 410 ACCU |
| 9. | 009410A | set of nozzles for HECHT 9410 |
| 10. | 009410B | prolonging rod for HECHT 9410 |

** Available from 2/25



HECHT 410 ACCU
ACCU KNAPSACK SPRAYER

Battery included



50 cm



| | | | | | |
|--|---------------------------|-----------------|--|----------------------|---------|
| | accu Li-ion | 10,8 V / 2,5 Ah | | container volume | 10 l |
| | max. pressure | 2,5 bar | | water flow | 1 l/min |
| | working time without load | cca 2,5 h | | weight | 2,9 kg |
| | charging time | cca 2,5 h | | spraying pole length | 50 cm |

* The spreading width depends mainly on the speed / movement and the type of spreading material.

ACCU AND PETROL SPRAYERS, GARDEN PUMP

ACCU program 5040

Li-ion Powered

HECHT 9415

ACCU KNAPSACK SPRAYER

Battery and charger not included

ECO FRIENDLY



| | | | | | |
|--|---------------------------|-------------------------|--|----------------------|---------|
| | accu Li-ion | DC 40 V, 2,5 / 4 / 5 Ah | | tank capacity | 15 l |
| | max. pressure | 2,8 bar | | water flow | 1 l/min |
| | working time without load | max. 16 h | | weight | 4 kg |
| | charging time | cca 2 h | | spraying pole length | 72 cm |

Li-ion Powered

HECHT 416 ACCU

ACCU KNAPSACK SPRAYER

Battery included

ECO FRIENDLY



50 cm

| | | | | | |
|--|---------------------------|-----------------|--|----------------------|---------|
| | accu Li-ion | 10,8 V / 2,5 Ah | | container volume | 16 l |
| | max. pressure | 2,5 bar | | water flow | 1 l/min |
| | working time without load | cca 2,5 h | | weight | 4 kg |
| | charging time | cca 3 h | | spraying pole length | 50 cm |

ACCESSORIES

HECHT 000431
SPRAY COVER

HECHT 000432
EXTENSION STEEL PIPE
60 CM

HECHT 000433
F-NOZZLE

HECHT 433

PETROL KNAPSACK SPRAYER



Nozzle 120 cm

| | | | | | |
|--|---------------|----------------------|--|------------------|----------|
| | engine HECHT | 4 stroke | | weight | 9,3 kg |
| | engine volume | 24,5 cm ³ | | container volume | 15 l |
| | engine output | 0,75 HP | | max. flow | ≤7 l/min |

HECHT 443

PETROL KNAPSACK MISTDUSTER

Including applicator for granules



With auxiliary pump

| | | | | | |
|--|---------------|--------------------|--|------------------|---------|
| | engine HECHT | 2 stroke | | weight | 10,6 kg |
| | engine volume | 43 cm ³ | | container volume | 14 l |
| | power output | 2,2 HP | | range | ≤12 m |

HECHT 459

PETROL KNAPSACK MISTDUSTER

Including applicator for granules



Can be used as a blower

With auxiliary pump

| | | | | | |
|--|---------------|----------------------|--|------------------|---------|
| | engine HECHT | 2 stroke | | weight | 10,5 kg |
| | engine volume | 59,2 cm ³ | | container volume | 14 l |
| | power output | 2,5 HP | | range | ≤16 m |

HECHT 3350

WATER BARREL PUMP

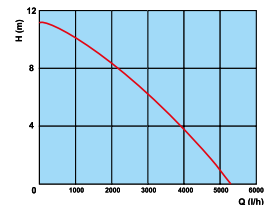

plastic chassis

plastic chassis

| | | | | | |
|--|-------------|-------------|--|-------------------------|----------|
| | electric | 230 V/50 Hz | | max. delivery height | 10 m |
| | power input | 350 W | | 10 m rubber power cable | |
| | clean water | | | max. delivery volume | 5000 l/h |

SUBMERSIBLE GARDEN PUMPS

HECHT 3400 SUBMERSIBLE PUMP



Recommended
accessory
**HECHT AQUA
1020**
WATER HOSE 20 M / 1"

plastic chassis

| | | | | | |
|--|-------------|-------------|--|-------------------------|----------|
| | electric | 230 V/50 Hz | | max.delivery height | 5 m |
| | power input | 400 W | | max. delivery volume | 7500 l/h |
| | dirty water | | | 10 m rubber power cable | |

HECHT 3752 SUBMERSIBLE PUMP



Recommended
accessory
**HECHT AQUA
1020**
WATER HOSE 20 M / 1"

plastic chassis

| | | | | | |
|--|-------------|-------------|--|-------------------------|-----------|
| | electric | 230 V/50 Hz | | max.delivery height | 8 m |
| | power input | 750 W | | max. delivery volume | 14000 l/h |
| | dirty water | | | 10 m rubber power cable | |

3in1

HECHT 3415 SUBMERSIBLE PUMP



1. **Min. suction level 1 mm**
2. **Clear water (2-3 mm grain)**
3. **Dirty water**

plastic chassis

| | | | | | |
|--|---------------------|-------------|--|-------------------------|-----------|
| | electric | 230 V/50 Hz | | max.delivery height | 6,3 m |
| | power input | 400 W | | max. delivery volume | 11500 l/h |
| | clean / dirty water | | | 10 m rubber power cable | |

HECHT 3775 SUBMERSIBLE PUMP



Recommended
accessory
**HECHT AQUA
1020**
WATER HOSE 20 M / 1"

Integrated float switch

Min. suction head level 70 mm

plastic chassis

| | | | | | |
|--|-------------|-------------|--|-------------------------|-----------|
| | electric | 230 V/50 Hz | | max.delivery height | 9 m |
| | power input | 750 W | | max. delivery volume | 13000 l/h |
| | dirty water | | | 10 m rubber power cable | |

HECHT 3011 SUBMERSIBLE PUMP



Recommended
accessory
**HECHT AQUA
1020**
WATER HOSE 20 m / 1"

inox chassis

| | | | | | |
|--|-------------|-------------|--|-------------------------|-----------|
| | electric | 230 V/50 Hz | | max.delivery height | 9,5 m |
| | power input | 1100 W | | max. delivery volume | 18000 l/h |
| | dirty water | | | 10 m rubber power cable | |

HECHT 3122 INOX SUBMERSIBLE PUMP



Multi stage pump
4 impellers

Recommended
accessory
**HECHT AQUA
1020**
WATER HOSE 20 M / 1"

inox chassis

| | | | | | |
|--|-------------|-------------|--|-------------------------|----------|
| | electric | 230 V/50 Hz | | max.delivery height | 44 m |
| | power input | 1200 W | | max. delivery volume | 5800 l/h |
| | clean water | | | 10 m rubber power cable | |

VIBRATION AND ELECTRIC PUMPS



HECHT 3301

VIBRATION
DROWNED PUMP

Vibration pump
- allows using in
drilled wells
from diameter
of 110 mm

300 W

steel chassis

| | | | | | |
|--|-------------|-------------|--|-------------------------|----------|
| | electric | 230 V/50 Hz | | max.delivery height | 55 m |
| | power input | 300 W | | max. delivery volume | 1400 l/h |
| | clean water | | | 10 m rubber power cable | |



HECHT 3166

VIBRATION
DROWNED PUMP

Vibration pump
- allows using in
drilled wells
from diameter
of 110 mm

600 W

steel chassis

| | | | | | |
|--|-------------|-------------|--|-------------------------|----------|
| | electric | 230 V/50 Hz | | max.delivery height | 70 m |
| | power input | 600 W | | max. delivery volume | 1400 l/h |
| | clean water | | | 10 m rubber power cable | |



HECHT 3520

DEEP WELL
PUMP

Borehole
diameter
11 cm

steel chassis

| | | | | | |
|--|-------------|-------------|--|-------------------------|----------|
| | electric | 230 V/50 Hz | | max.delivery height | 55 m |
| | power input | 1000 W | | max. delivery volume | 5200 l/h |
| | clean water | | | 20 m rubber power cable | |



HECHT 3080

GARDEN PUMP

| | | | | | |
|--|---------------------|-------------|--|----------------------|----------|
| | electric | 230 V/50 Hz | | max. delivery volume | 3200 l/h |
| | power input | 800 W | | max.suction lift | 7 m |
| | max. pressure | 4 bar | | weight | 6,9 kg |
| | max.delivery height | 40 m | | | |



HECHT 3131

GARDEN PUMP

| | | | | | |
|--|---------------------|---------------|--|----------------------|----------|
| | electric | 230 V / 50 Hz | | max. delivery volume | 4600 l/h |
| | power input | 1100 W | | max.suction lift | 8 m |
| | max. pressure | 4,5 bar | | weight | 10 kg |
| | max.delivery height | 45 m | | | |



HECHT 3800

GARDEN PUMP

| | | | | | |
|--|---------------------|---------------|--|----------------------|----------|
| | electric | 230 V / 50 Hz | | max. delivery volume | 3200 l/h |
| | power input | 800 W | | max.suction lift | 8 m |
| | max. pressure | 3,6 bar | | tank volume | 20 l |
| | max.delivery height | 38 m | | weight | 12,3 kg |

HECHT 000031

7m / 1" SUCTION HOSE
with possibility of easy
shortening for the length
required.



ELECTRIC AND PETROL PUMPS

GARDEN

HECHT 3101 INOX GARDEN PUMP



| | | | | | |
|--|---------------------|---------------|--|----------------------|----------|
| | electric | 230 V / 50 Hz | | max. delivery volume | 3500 l/h |
| | power input | 1000 W | | max.suction lift | 7 m |
| | max. pressure | 3 bar | | tank volume | 19 l |
| | max.delivery height | 44 m | | weight | 13,3 kg |

HECHT 3331 GARDEN PUMP



| | | | | | |
|--|---------------------|---------------|--|----------------------|----------|
| | electric | 230 V / 50 Hz | | max. delivery volume | 4600 l/h |
| | power input | 1100 W | | max.suction lift | 8 m |
| | max. pressure | 4,5 bar | | tank volume | 24 l |
| | max.delivery height | 45 m | | weight | 18 kg |

HECHT 352 PETROL GARDEN PUMP



Suction strainer included

| | | | | | |
|--|----------------------|--------------------|--|----------------------|------------|
| | engine HECHT | 2-stroke | | max.suction lift | 8 m |
| | engine volume | 43 cm ³ | | max. delivery volume | 15 000 l/h |
| | max. delivery height | 35 m | | weight | 9,5 kg |

HECHT 3635 PETROL PUMP



| | | | | | |
|--|----------------------|---------------------|--|----------------------|-----------|
| | engine HECHT | OHV, 4-stroke | | max.suction lift | 8 m |
| | engine volume | 212 cm ³ | | max. delivery volume | 36000 l/h |
| | max. delivery height | 28 m | | weight | 23,5 kg |

HECHT 3680 PETROL PUMP

FOR DIRTY WATER



| | | | | | |
|--|----------------------|---------------------|--|----------------------|-----------|
| | engine HECHT | OHV, 4-stroke | | max.suction lift | 7 m |
| | engine volume | 196 cm ³ | | max. delivery volume | 45000 l/h |
| | max. delivery height | 23 m | | weight | 37 kg |

GREENHOUSES

HECHT TILT II

GARDEN FOIL

Spacious foil

UV resistant film

Galvanised steel frame 0.5 mm

Tube diameter 16 mm

2 shelves around the entire inner perimeter



TUNNEL I

GARDEN FOIL

Spacious foil

UV resistant film

Galvanised steel frame 0.5 mm

Tube diameter 25 mm



| | | | | | |
|--|------------------------|----------------|--|---|---------------------|
| | dimensions | 140x140x200 cm | | area | 1,96 m ² |
| | galvanized steel tubes | Ø 0,5 mm | | green PE mesh cloth 140 g/m ² , 1 door | |

| | | | | | |
|--|------------------------|--------------------|--|--|------------------|
| | dimensions | 300 x 200 x 200 cm | | area | 6 m ² |
| | galvanized steel tubes | Ø 0,5 mm | | green PE mesh cloth 140 g/m ² , 6 windows, 1 door | |

HECHT GREENHOUSE I.

GREENHOUSE

1 roof vent

Door 59x164 cm

Perfectly transmits solar radiation (about 80 %), at the same time protects against harmful UV radiation.

ALU frame 1,2 mm + Polycarbonate

BASE INCLUDED (GALVANIZED STEEL)



000608
AUTO VENT OPENER

Suitable for HECHT GREENHOUSE I. and HECHT RANCHER II.

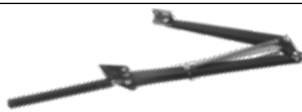

| | | | | | |
|--|------------|----------------|--|------------------------------|--------------------|
| | dimensions | 250x190x195 cm | | area | 4,8 m ² |
| | alu frame | Ø 1,2 mm | | 4 mm twin wall polycarbonate | |

HECHT RANCHER II.

GREENHOUSE

ALU frame 1,2 mm + Polycarbonate

BASE INCLUDED (GALVANIZED STEEL)

2 roof vents

Door 59x164 cm

Perfectly transmits solar radiation (about 80 %), at the same time protects against harmful UV radiation.



| | | | | | |
|--|------------|----------------|--|------------------------------|---------------------|
| | dimensions | 311x190x195 cm | | area | 5,91 m ² |
| | alu frame | Ø 1,2 mm | | 4 mm twin wall polycarbonate | |

HOSE CONNECTIONS, EXTENTIONS AND GUNS

GARDEN

CONNECTION

TAP EXTENSION

CONNECTION

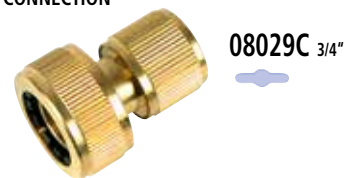
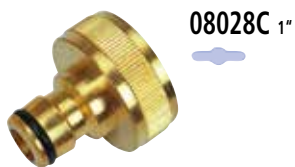
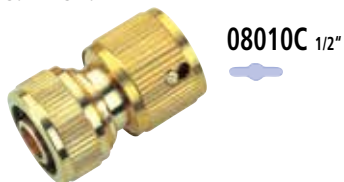

SPRAYING GUN

TAP EXTENSION

IRRIGATION NOZZLE



CONNECTION

HECHT 08010

HECHT 08011

HECHT 08029

HECHT 08111



TAP EXTENSION

HECHT 08023

HECHT 08024

TWO-WAY CONNECTION

HECHT 08016

IMPLUSE SPRINKLER
HECHT 02677



CONNECTION SET
HECHT 08025

SPRINKLER
HECHT 08109

MECHANICAL TIMER
HECHT 08901

ELECTRONIC TIMER
HECHT 08907

TWO-WAY TAP EXTENSION
HECHT 08002



TWO-WAY TAP EXTENSION

IMPLUSE SPRINKLER

HECHT 08104

HECHT 01023

HECHT 08103

HECHT 06043

HECHT 06023



EXTENTIONS, GUNS AND HOSES

SHOWERS

HECHT 08230

65 cm

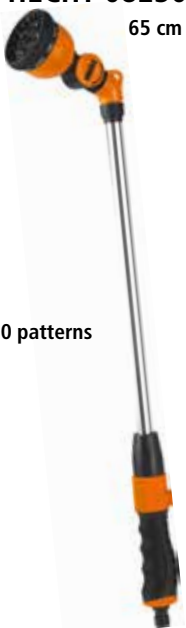

HECHT 00202

172-229 cm



10 patterns



8 PATTERN OSCILLATING SPRINKLER 3 IN 1

HECHT 06018



2bar_{min}
4bar_{max}



Max
8L/min

0-360°

8 patterns:
circle, semicircle, rectangle, sector,
shower, square, triangle, semiflat

OSCILLATING SPRINKLERS

HECHT 08601

max. 4 bar,
12,4 m diameter



2bar_{min}
4bar_{max}

Max
30L/min

R 6,2m
121m²

0-360°

8 PATTERN SPRINKLER

HECHT 07060



2bar_{min}
4bar_{max}

Max
20L/min

280m²

pressure 2-4 bar, max. 20 l/min,
max. area 280 m²

HECHT 08702

17 holes



2bar_{min}
4bar_{max}

Max
20L/min



342m²

SPRAYING GUNS

HECHT 02063



HECHT 02064

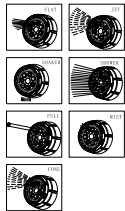

HECHT 02094

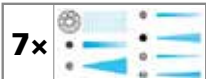

HOSE REEL

HECHT 08666

20 m of 1/2" hose
Hose and accessories
included



1/2"
20m

1/2" 5/8"

1/2" 3/4"



HECHT 00627

max 50 m of 1/2" hose



HOSE CART

HECHT 08623

hose 50 m of 1/2"



3/4"
Max.
45m

1/2"
Max.
50m



HOSE

HECHT 05915



1/2"

15m

1/2" 3/4"



HOSE HANGER

HECHT 00632

L: 250mm
W: 121mm
H: 151mm



HECHT 00638

hose 100 m of 1/2"



3/4"
Max.
60m

1/2"
Max.
100m

HOSES, HIGH PRESSURE WASHERS

GARDEN

HECHT AQUA 1215

WATER HOSE 15 M / 1/2"



High quality garden hoses

OK
10 bar

Max
30 bar



Max. working pressure 10 Bar,
max. total pressure 30 Bar (for 1215 and 1225).

HECHT AQUA 3415

WATER HOSE 15 M / 3/4"



HECHT AQUA 1225

WATER HOSE 25 M / 1/2"



HECHT AQUA 1020

WATER HOSE 20 M / 1"



MADE IN
CZECH
REPUBLIC

HECHT AQUA 3425

WATER HOSE 25 M / 3/4"



HECHT 322

HIGH PRESSURE WASHER



Side view



Selfpriming
Easy handling

SELF SUCTION HOSE -
0000324 (NOT INCLUDED)



HECHT 333

HIGH PRESSURE WASHER

NEW



Side view



Selfpriming
Easy handling

SELF SUCTION HOSE -
0000324 (NOT INCLUDED)



| | | | | | |
|---|---|---------------|---|-------------------|----------|
| ⚡ | electric | 230 V / 50 Hz | 📏 | delivery volume | 420 l/h* |
| ⚡ | power input | 1800 W | 📏 | weight | 6,1 kg |
| ⚡ | max. pressure | 140 bar | 📏 | hose length | 5 m |
| ⚡ | working pressure | 100 bar | 📏 | power cord length | 5 m |
| ✓ | high pressure hose with gun, water inlet connector, adjustable nozzle | | | | |

| | | | | | |
|---|--|---------------|---|-------------------|----------|
| ⚡ | electric | 230 V / 50 Hz | 📏 | delivery volume | 450 l/h* |
| ⚡ | power input | 2000 W | 📏 | weight | 8,2 kg |
| ⚡ | max. pressure | 160 bar | 📏 | hose length | 5 m |
| ⚡ | working pressure | 110 bar | 📏 | power cord length | 5 m |
| ✓ | variojet, bottle for cleaner with foam jet, power cable 5 m, high pressure hose with gun 5 m, accessories hook | | | | |



HECHT 324

HIGH PRESSURE WASHER

Possibility of
independent
water suction or
connection
to the supply



Side view



Adaptor for
accessories 000318
and 000326 included

SELF SUCTION HOSE -
0000324 (NOT INCLUDED)



| | | | | | |
|---|--|---------------|---|-------------------|----------|
| ⚡ | electric | 230 V / 50 Hz | 📏 | delivery volume | 360 l/h* |
| ⚡ | power input | 2000 W | 📏 | weight | 12,3 kg |
| ⚡ | max. pressure | 150 bar | 📏 | hose length | 8 m |
| ⚡ | working pressure | 100 bar | 📏 | power cord length | 5 m |
| ✓ | bottle for cleaner with foam jet, high pressure hose with gun 8 m, power cable 5 m, adaptor for selected accessories | | | | |

* Maximum inlet water temperature 50°C.

HIGH PRESSURE WASHERS

HECHT 326 HIGH PRESSURE WASHER



| | | | | | |
|------------|--|---------------|---|-------------------|----------|
| ⚡ | electric | 230 V / 50 Hz | → | delivery volume | 420 l/h* |
| ⚡ | power input | 2600 W | ⚖ | weight | 22,7 kg |
| max ↓↓↓ | max. pressure | 200 bar | → | hose length | 5 m |
| ↓↓↓ | working pressure | 135 bar | → | power cord length | 5 m |
| ✓ | variojet, bottle for cleaner with foam jet, power cable 5 m, high pressure hose with gun 5 m | | | | |

HECHT 3025 ACCU HIGH PRESSURE WASHER

Li-ion
Powered

ACCU
program
6020

Selfsuction hose
included



| | | | | | |
|------------|----------------------|-----------------------|---|----------------------------------|-----------|
| ⚡ | Accu Li-ion | DC 20 V 1 × 2,5 Ah | ⚖ | weight | 1,3 kg |
| max ↓↓↓ | max. pressure | 22 bar | 🕒 | charging time | ≤ 20 min. |
| ↓↓↓ | working pressure | 8 bar | 🕒 | working time | 2 h |
| → | max. delivery volume | 180 l/h* | 🚫 | battery and charger not included | |

4m selfsuction
hose included

HECHT 3425 ACCU HIGH PRESSURE WASHER

ACCU
program
6020



Li-ion
Powered

2 × 20 V



| | | | | | |
|------------|----------------------|-----------------------|---|----------------------------------|-----------|
| ⚡ | Accu Li-ion | DC 20 V 2 × 2,5 Ah | ⚖ | weight | 6,8 kg |
| max ↓↓↓ | max. pressure | 40 bar | 🕒 | charging time | ≤ 20 min. |
| ↓↓↓ | working pressure | 40 bar | 🕒 | working time | 2 h |
| → | max. delivery volume | 240 l/h* | 🚫 | battery and charger not included | |

HECHT 3230 PETROL HIGH PRESSURE WASHER

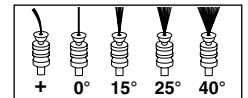

| | | | | | |
|---|---|---------------------|------------|-----------------|----------|
| 🔧 | engine HECHT | 4-taktní | max ↓↓↓ | max. pressure | 207 bar |
| 🔧 | engine volume | 196 cm ³ | → | delivery volume | 681 l/h* |
| ⚙ | max. torque | 12,7 Nm | ⚖ | weight | 37,5 kg |
| → | hose length | 10 m | 🚗 | wheels | 3/8" |
| ⓘ | 10 m pressure hose with gun, hose for cleaner, 5 jets, hose holder, gun holder, cleaning tool | | | | |

Accessories for HECHT high-pressure washers

HECHT 000317



This equipment is approved solely for cleaning blockages from pipes, down pipes, drains and toilets (for HECHT 318, 322, 326, 333, 3230 use the reduction H318326).



ROTATING BRUSH - 000318
(for HECHT 318, 322, 326, 333, 3220, 3230, 3227 use the reduction H318326)

ROTATING BRUSH FOR THE TERRACE CLEANING - 000326
(for HECHT 318, 322, 326, 333, 3220, 3230, 3227 use the reduction H318326)



REDUCTION
Part no.:
H318326



| | | |
|----------------|---|--|
| 000320A | PATIO CLEANER pro HECHT 320, 323 | |
| 000320B | BRUSH pro HECHT 320, 323 | |
| 000320C | TURBO NOZZLE pro HECHT 320, 323 | |
| 000320D | PRESSURE HOSE 10 M pro HECHT 320, 323 | |
| 000320E | ROTARY BRUSH pro HECHT 319, 320, 323, 351 | |
| 000320F | ANGLE NOZZLE pro HECHT 320, 323 | |

ASH SEPARATORS, VACUUM CLEANERS

HECHT 12E ASH SEPARATOR

800 W

Container 12 L

Package contents:
- prefilter
- filter element
- metal mesh cover



| | | | | | |
|--|-------------|-------------|--|-------------|------------|
| | electric | 230 V/50 Hz | | tank volume | 12 l |
| | power input | 800 W | | air flow | 1,5 m³/min |

HECHT 22E ASH SEPARATOR

Filter cleaning function

1200 W

20 L



| | | | | | |
|--|-------------|-------------|--|-------------|------|
| | electric | 230 V/50 Hz | | tank volume | 20 l |
| | power input | 1200 W | | | |

ACCESSORIES for HECHT vacuum cleaners

| Order No. | Product |
|---------------|--|
| HECHT 008215A | HEPA FILTER for HECHT 8215, 8330, 8335Z |
| HECHT 008215B | FOAM FILTER for HECHT 8215, 8330, 8335Z |
| HECHT 008215C | TEXTILE PREFILTER for HECHT 8215, 8320, 8330, 8335Z |
| HECHT 008215D | REPLACEMENT PAPER FILTER for HECHT 8215, 8320 – 3 pcs/pac. |
| HECHT 008335D | REPLACEMENT PAPER FILTER for HECHT 8330, 8335Z – 3 pcs/pac. |



HECHT 8215 VACUUM CLEANER



Wet & dry cleaning

15 kPa
15 l

1250 W

| | | | | | |
|--|-------------|-------------|--|-------------|-------|
| | electric | 230 V/50 Hz | | tank volume | 15 l |
| | power input | 1250 W | | weight | 4 kg |
| | vacuity | 15 kPa | | hose | 1,5 m |

HECHT 8330 VACUUM CLEANER



HECHT 008330
5 M HOSE FOR
HECHT 8320,
8330, 8335Z



Wet & dry cleaning

18 kPa
30 l
1400 W

Can be used as a blower

| | | | | | |
|--|-------------|-------------|--|-------------|--------|
| | electric | 230 V/50 Hz | | tank volume | 30 l |
| | power input | 1400 W | | weight | 5,6 kg |
| | vacuity | 18 kPa | | hose | 1,5 m |

HECHT 8335Z VACUUM CLEANER



1400 W

With socket
230 V / 50 Hz

Max. 2000 W
Socket turns on the vacuum cleaner about 3 seconds after switching on the device in the socket (eg drills).

Can be used as a blower

| | | | | | |
|--|-------------|-------------|--|-------------|--------|
| | electric | 230 V/50 Hz | | tank volume | 35 l |
| | power input | 1400 W | | weight | 6,6 kg |
| | vacuity | 18 kPa | | hose | 1,5 m |

VACUUM CLEANER, ELECTRIC HOISTS, RAMMER

HECHT 008380A FRONT VACUUMING BRUSH



HECHT 08380 7M HOSE Ø 38 mm for HECHT 8360, 8380



3 MOTORS
3000 W
23 KPA

HECHT 8380 VACUUM CLEANER

PROFI TOOL



Available
from 2/25

| | | | | | |
|---|-------------|-------------|---|--------------------|--------|
| ⚡ | electric | 230 V/50 Hz | 🌀 | vacuity | 23 kPa |
| 🔌 | power input | 3000 W | 📏 | hose length | 3 m |
| 📦 | tank volume | 80 l | 🌀 | hose diameter | 4,5 cm |
| 👤 | weight | 29 kg | 🔌 | power cable length | 4 m |

HECHT 8490 CHAIN HOIST



HECHT 8425 ELECTRIC CABLE HOIST



The fixing accessories
is included

450 W

| | | | | | |
|----|----------------|-----------|---|-------------------------|-------|
| 🗑️ | max. load | 1000 kg | 🌀 | fastening hook diameter | 23 mm |
| 👤 | weight | 8 kg | 🌀 | load hook diameter | 23 mm |
| 🌀 | chain diameter | 6 x 18 mm | 📏 | chain length | 3 m |

| | | | | | |
|---|----------------------------|---------------|---|--|--------------|
| ⚡ | electric | 230 V / 50 Hz | 📏 | load without pulley / with pulley | 125 / 250 kg |
| 🔌 | power input | 450 W | 📏 | stroke height without pulley / with pulley | 12 / 6 m |
| 🌀 | wire diameter | 3 mm | 📏 | stroke speed without pulley / with pulley | 8 / 4 m/min |
| 🔌 | control panel cable length | 1,6 m | 📏 | power cord length | 0,65 m |

HECHT 8450 ELECTRIC CABLE HOIST



The fixing accessories
is included

800 W

| | | | | | |
|---|----------------------------|---------------|---|--|--------------|
| ⚡ | electric | 230 V / 50 Hz | 📏 | load without pulley / with pulley | 250 / 500 kg |
| 🔌 | power input | 800 W | 📏 | stroke height without pulley / with pulley | 12 / 6 m |
| 🌀 | wire diameter | 4 mm | 📏 | stroke speed without pulley / with pulley | 8 / 4 m/min |
| 🔌 | control panel cable length | 1,6 m | 📏 | power cord length | 0,65 m |

HECHT 1121 UPRIGHT RAMMER



NEW

Powered By
LONCIN

| | | | | | |
|---|--------------|---------------------|---|---------------------|---------------------------|
| 🔧 | engine | OHV | 📏 | compaction pressure | 10000 N |
| 📏 | displacement | 196 cm ³ | 📏 | max. jumping stroke | 6,5 cm |
| 🌀 | max.torque | 12,4 | 📏 | dimensions of plate | 345 x 285 mm |
| 👤 | weight | 82 kg | 📏 | impact | 450-650 min ⁻¹ |

COMPACTORS, CONCRETE CUTTERS

Model 2025



HECHT 1111
PLATE COMPACTOR

84 cm

113 cm

38 cm

Folding wheels and damping pad included

Powered By **Loncin**

steel chasis

| | | | | |
|--|--------------|---------------------|---------------------|--------------|
| | engine | OHV | compaction pressure | 11000 N |
| | displacement | 196 cm ³ | compaction depth | 25 cm |
| | max.torque | 12,4 Nm | dimensions of plate | 530 × 370 mm |
| | weight | 63 kg | | |

Model 2025



HECHT 1113
PLATE COMPACTOR

84 cm

113 cm

43 cm

Folding wheels and damping pad included

Powered By **Loncin**

steel chasis

| | | | | |
|--|--------------|---------------------|---------------------|--------------|
| | engine | OHV | compaction pressure | 13000 N |
| | displacement | 196 cm ³ | compaction depth | 30 cm |
| | max.torque | 12,4 Nm | dimensions of plate | 540 × 420 mm |
| | weight | 83 kg | | |

Model 2025



HECHT 1114
PLATE COMPACTOR

84 cm

113 cm

51 cm

Folding wheels and damping pad included

Powered By **Loncin**

steel chasis

| | | | | |
|--|--------------|---------------------|---------------------|--------------|
| | engine | OHV | compaction pressure | 20000 N |
| | displacement | 196 cm ³ | compaction depth | 35 cm |
| | max.torque | 12,4 Nm | dimensions of plate | 580 × 500 mm |
| | weight | 92 kg | | |

Powered By **Loncin**



HECHT 1900
CONCRETE CUTTER

HECHT 001900
SPARE DIAMOND BLADE
FOR HECHT 1900

steel chasis

| | | | | |
|--|--------------|---------------------|------------------------------------|--------------|
| | engine | OHV | max. cutting depth | 10,5 cm |
| | displacement | 196 cm ³ | blade diameter | 350 mm / 14" |
| | weight | 102 kg | water cooling, water tank capacity | 14 l |

HECHT 1902
CONCRETE CUTTER

NEW



HECHT 001902
SPARE DIAMOND BLADE
FOR HECHT 1902

Available from 4/25

| | | | | |
|--|--------------|---------------------|------------------------------------|--------------|
| | engine | OHV | max. cutting depth | 14 cm |
| | displacement | 389 cm ³ | blade diameter | 450 mm / 18" |
| | weight | 113 kg | water cooling, water tank capacity | 35 l |

HECHT 9588
PETROL CUT-OFF CHAIN SAW

★★★★★



Carrying case included

Spare saw blade
nr.: 958800134

| | | | | |
|--|---------------|--------------------|------------------|--------|
| | engine volume | 54 cm ³ | Ø blade diameter | 305 mm |
| | power output | 3,4 HP | weight | 9,8 kg |

CONCRETE CUTTER, DUMPERS



HECHT 9744
PETROL CUT-OFF CHAIN SAW

NEW

★★★★★

| | | | | | |
|--|---------------|--------------------|--|----------------|---------|
| | engine volume | 74 cm ³ | | blade diameter | 350 mm |
| | power output | 4,8 HP | | weight | 10,1 kg |



HECHT 2620
ACCU WHEELBARROW



ECO FRIENDLY

| | | | | | |
|--|----------------|---------|--------------|-------------------|--------|
| | self-propelled | | max capacity | 80 l | |
| | accu | 24 V | | max speed | 6 km/h |
| | power input | 280 W | | weight | 40 kg |
| | wheel | 5.00-8" | | charging time | 7 hrs |
| | max load | 260 kg | | max. working time | 10 hrs |

www.hecht.cz



HECHT 2623
ACCU WHEELBARROW

NEW

HECHT 002623 optional

ECO FRIENDLY

| | | | | | |
|--|----------------|---------|--------------|-------------------|--------|
| | self-propelled | | max capacity | 100 l | |
| | accu | 24 V | | max speed | 6 km/h |
| | power input | 280 W | | weight | 50 kg |
| | wheel | 5.00-8" | | charging time | 7 h |
| | max load | 260 kg | | max. working time | 7 h |



HECHT 2636
PETROL TRANSPORTER

300 KG LOAD

Powered By **Loncin**

steel chassis

| | | | | | |
|----------------|--------------|----------------------------|--|----------|-------------------|
| | engine | 4-stroke | | max load | 300 kg |
| | displacement | 196 cm ³ | | weight | 160 kg |
| | max. torque | 12,4 Nm | | bed size | 94 × 63,5 × 33 cm |
| self propelled | | 3 gears forward, 1 reverse | | | |



HECHT 2650
PETROL TRANSPORTER

500 KG LOAD

Powered By **Loncin**

front doublewheels
steel chassis

| | | | | | |
|----------------|--------------|----------------------------|--|----------|---------------------|
| | engine | 4-stroke | | max load | 500 kg |
| | displacement | 196 cm ³ | | weight | 170 kg |
| | max. torque | 12,4 Nm | | bed size | 1050 × 750 × 700 mm |
| self propelled | | 3 gears forward, 1 reverse | | | |



HECHT 2625
ACCU TRANSPORTER

ELECTRIC MOTOR
500 KG LOAD
HYDRAULIC LIFTING

ECO FRIENDLY

steel chassis

| | | | | | |
|----------------|---------------|--------------|--|-------------------|--------|
| | accu | 48 V / 45 Ah | | max load | 500 kg |
| | power input | 1000 W | | weight | 136 kg |
| | working time | 8,4 hrs | | bed capacity | 260 l |
| | charging time | 9 hrs | | max speed forward | 6 km/h |
| self propelled | | | | | |

DUMPERS, STIRRERS

HECHT 2950 TRACKS TRANSPORTER



| | | | | | |
|--|--------------|---------------------|--|----------|---------------------|
| | engine | 4-stroke | | max load | 500 kg |
| | displacement | 270 cm ³ | | weight | 270 kg |
| | max. torque | 17,7 Nm | | bed size | 1000 x 700 x 450 mm |

self propelled - 3 gears forward, 1 reverse

HECHT 2960 TRACKS TRANSPORTER



| | | | | | |
|--|--------------|---------------------|--|----------|-------------------|
| | engine | 4-stroke | | max load | 500 kg |
| | displacement | 270 cm ³ | | weight | 442 kg |
| | max. torque | 17,7 Nm | | bed size | 95 x 68 x 46,5 cm |

Self propelled

HECHT 2955 TRACKS TRANSPORTER



| | | | | | |
|--|--------------|---------------------|--|----------|---------------------|
| | engine | 4-stroke | | max load | 500 kg |
| | displacement | 270 cm ³ | | weight | 366 kg |
| | max. torque | 17,7 Nm | | bed size | 1065 x 715 x 660 mm |

Self propelled, hydrostatic transmission

HECHT 2980 TRACKS TRANSPORTER



| | | | | | |
|--|--------------|---------------------|--|----------|----------------|
| | engine | 4-stroke | | max load | 800 kg |
| | displacement | 420 cm ³ | | weight | 365 kg |
| | max. torque | 26,5 Nm | | bed size | 95 x 68 x 46,5 |

Self propelled - 6 gears forward, 2 reverse

HECHT 1146 PAINT AND MORTAR STIRRER



| | | | | | |
|--|---------------|---------------------|--|---------------|--------|
| | electric | 230 V / 50 Hz | | tool diameter | 140 mm |
| | power input | 1600 W | | tool height | 590 mm |
| | no load speed | 0-640/0-940 ot./min | | weight | 3,5 kg |

with mixing tool (connection M14)

HECHT 1140 PAINT AND MORTAR STIRRER



| | | | | | |
|--|---------------|-----------------|--|---------------|---------|
| | electric | 230 V / 50 Hz | | tool diameter | 140 mm |
| | power input | 1800 W | | tool height | 590 mm |
| | no load speed | 0-440/0-780 rpm | | weight | 7,25 kg |

with mixing tool (connection M14)

HECHT 1142 ACCU PAINT AND MORTAR STIRRER



| | | | | | |
|--|---------------|------------------|--|---------------|--------|
| | accu Li-ion | 20 V | | tool diameter | 100 mm |
| | battery | 2 / 4 / 6 / 8 Ah | | tool height | 590 mm |
| | no load speed | 0-710 rpm | | weight | 5,2 kg |

with mixing tool (connection M14)

MIXERS, PETROL GENERATORS

HECHT 2117 MIXER



Real drum volume 120 l

Rubber wheels
550 W

transmission detail



HECHT 2141 MIXER



Real drum volume 140 l

Rubber wheels
650 W

transmission detail



| | | | | | |
|---|-------------|-------------|---|-------------|---------|
| ⚡ | electric | 230 V/50 Hz | 👤 | weight | 49,5 kg |
| 🔌 | power input | 550 W | 🗄 | drum volume | 120 l |

| | | | | | |
|---|-------------|-------------|---|-------------|---------|
| ⚡ | electric | 230 V/50 Hz | 👤 | weight | 51,5 kg |
| 🔌 | power input | 650 W | 🗄 | drum volume | 140 l |

HECHT 2185 MIXER



Real drum volume 180 l

Rubber wheels
850 W

transmission detail



HECHT 2223 MIXER



Real drum volume 200 l

1100 W

Big rubber wheels
for easy transport

Massive frame

| | | | | | |
|---|-------------|-------------|---|-------------|---------|
| ⚡ | electric | 230 V/50 Hz | 👤 | weight | 55,5 kg |
| 🔌 | power input | 850 W | 🗄 | drum volume | 180 l |

| | | | | | |
|---|-------------|-------------|---|-------------|---------|
| ⚡ | electric | 230 V/50 Hz | 👤 | weight | 81,5 kg |
| 🔌 | power input | 1100 W | 🗄 | drum volume | 200 l |

HECHT GG 950 SINGLE PHASE GENERATOR



2-stroke engine

| | | | | | |
|---|--------------------------|---------------------------|---|-------------|-----------|
| 🗄 | displacement | 63 cm ³ / 2 HP | ⚡ | voltage | ~230 V |
| 🌀 | max. torque | 2,6 Nm | 🔊 | noise level | 95 dB |
| ⚡ | DC 230 V | 2,83 A | 🗄 | tank | 4,2 l |
| ⚡ | steady electrical output | 650 W | 👤 | weight | 16,5 kg |
| ⚡ | max. electrical output | 720 W | 🔌 | sockets | 1 × 230 V |
| ⓘ | fuse | | | | |

HECHT GG 2500 SINGLE PHASE GENERATOR



4-stroke engine

| | | | | | |
|---|---|---------------------|---|-------------|---------------------------|
| 🗄 | displacement | 196 cm ³ | ⚡ | voltage | ~230 V/12 V |
| 🌀 | max. torque | 11,5 Nm | 🔊 | noise level | 90 dB |
| ⚡ | DC 12 V/230 V | 8,3/8,7 A | 🗄 | tank | 15 l |
| ⚡ | steady electrical output | 2000 W | 👤 | weight | 39 kg |
| ⚡ | max. electrical output | 2200 W | 🔌 | sockets | 1 × 12 V DC, 2 × 230 V |
| ⓘ | fuse, voltmeter, automatic voltage regulation | | | | |

PETROL GENERATORS

HECHT GG 3300

SINGLE PHASE GENERATOR

AVR



4-stroke engine

| | | | | | |
|--|---|---------------------|--|-------------|------------------------|
| | displacement | 208 cm ³ | | voltage | ~230 V/12 V |
| | max. torque | 10,8 Nm | | noise level | 96 dB |
| | DC 12V/230V | 8,3/11,3 A | | tank | 15 l |
| | steady electrical output | 2600 W | | weight | 46,5 kg |
| | max. electrical output | 3000 W | | sockets | 1 x 12 V DC, 2 x 230 V |
| | fuse, voltmeter, automatic voltage regulation | | | | |

HECHT GG 3300W

SINGLE PHASE GENERATOR

AVR



Folding handle

4-stroke engine

| | | | | | |
|--|--|---------------------|--|-------------|------------------------|
| | displacement | 208 cm ³ | | voltage | ~230 V/12 V |
| | max. torque | 10,8 Nm | | noise level | 96 dB |
| | DC 12V/230V | 8,3 / 11,3 A | | tank | 15 l |
| | steady electrical output | 2600 W | | weight | 48 kg |
| | max. electrical output | 3000 W | | sockets | 1 x 12 V DC, 2 x 230 V |
| | fuse, voltmeter, automatic voltage regulation, wheels and folding handle for easier handling | | | | |

HECHT GG 6500

SINGLE PHASE GENERATOR

AVR

Folding handle



4-stroke engine

| | | | | | |
|--|--|---------------------|--|-------------|------------------------|
| | displacement | 389 cm ³ | | voltage | ~230 V/12 V |
| | max. torque | 23 Nm | | noise level | 96 dB |
| | DC 12V/230V | 8,3/21,7 A | | tank | 25 l |
| | steady electrical output | 5000 W | | weight | 84 kg |
| | max. electrical output | 5500 W | | sockets | 1 x 12 V DC, 3 x 230 V |
| | fuse, digital voltmeter, automatic voltage regulation, e-start, folding handle, socket counterparts included | | | | |

HECHT GG 8000

THREE-PHASE GENERATOR

AVR

Folding handle



4-stroke engine

| | | | | | |
|--|--|---------------------|--|-------------|-----------------------------------|
| | displacement | 420 cm ³ | | voltage | ~230 V / 400 V =12 V |
| | max. torque | 24,5 Nm | | noise level | 98 dB |
| | DC 12V/230V | 8,3/9,4 A | | tank | 25 l |
| | steady electrical output | 6500 W | | weight | 88 kg |
| | max. electrical output | 7000 W | | sockets | 1 x 12 V DC, 2 x 230 V, 1 x 400 V |
| | fuse, digital voltmeter, automatic voltage regulation, e-start, folding handle, socket counterparts included | | | | |

HECHT GG 10000

THREE-PHASE GENERATOR

AVR

Folding handle



4-stroke engine

| | | | | | |
|--|--|---------------------|--|-------------|-----------------------------------|
| | displacement | 459 cm ³ | | voltage | ~230 V / 400 V =12 V |
| | max. torque | 29 Nm | | noise level | 97 dB |
| | DC 12V/230V | 8,3/10,8 A | | tank | 25 l |
| | steady electrical output | 7500 W | | weight | 102 kg |
| | max. electrical output | 8500 W | | sockets | 1 x 12 V DC, 2 x 230 V, 1 x 400 V |
| | fuse, digital voltmeter, automatic voltage regulation, e-start, folding handle, socket counterparts included | | | | |

HECHT GG 11000

SINGLE/THREE-PHASE HYBRID GENERATOR

AVR



4-stroke engine

| | | | | | |
|--|--|---------------------|--|---------|---|
| | displacement | 459 cm ³ | | voltage | ~230 V / 400 V =12 V |
| | output power | 16 HP | | tank | 25 l |
| | steady electrical output | 8000 W | | weight | 105 kg |
| | max. electrical output | 8500 W | | sockets | 1 x 12 V DC, 1 x 230 V / 16 A, 1 x 230 V / 32 A, 1 x 400 V / 16 A |
| | automatic voltage regulation, e-start, 12V DC terminal clamps, wheels, folding handles, single/three phase hybrid system | | | | |

PETROL GENERATORS, CHARGERS

HECHT IG 1101

SINGLE PHASE
INVERTOR

Ideal for
camping
and fishing

Low weight



4-stroke engine

| | | | | | |
|--|--------------------------|--------------------|--|-------------|------------------|
| | displacement | 56 cm ³ | | voltage | ~230 V |
| | max. torque | 2,8 Nm | | noise level | 95 dB |
| | DC 230 V | 4,3 A | | weight | 12,5 kg |
| | steady electrical output | 1000 W | | tank | 2,8 l |
| | max. electrical output | 1100 W | | sockets | 1×230 V 2×5 V |

HECHT IG 2201

SINGLE PHASE
INVERTOR

Also suitable
for powering
sensitive
electronics

Ideal for
camping
and fishing

Low weight



4-stroke engine

| | | | | | |
|--|--------------------------|----------------------|--|-------------|-------------------------|
| | displacement | 79,8 cm ³ | | voltage | ~230 V/12/5 V |
| | max. torque | 4,5 Nm | | noise level | 89 dB |
| | 5V/12V/230V | 1; 2, 1/8, 3/7, 8 A | | weight | 18,5 kg |
| | steady electrical output | 1800 W | | tank | 4 l |
| | max. electrical output | 2000 W | | sockets | 1×230 V, 1×12V, 2×5V |

NEW

HECHT IG 3601

SINGLE PHASE OPEN FRAME
INVERTOR

2× USB

Also suitable
for powering
sensitive
electronics

Available
from 3/25



4-stroke engine

| | | | | | |
|--|--------------------------|---------------------|--|-------------|---------------------------|
| | displacement | 208 cm ³ | | voltage | ~230 V/12/5 V |
| | max. torque | 11,5 Nm | | noise level | 96 dB |
| | 5V/12V/230V | 3; 3,6/8,3/13 A | | weight | 26 kg |
| | steady electrical output | 3000 W | | tank | 7,5 l |
| | max. electrical output | 3300 W | | sockets | 2×230 V, 1×12 V, 2×5 V |

HECHT IG 4500

SINGLE PHASE
INVERTOR

Also suitable
for powering
sensitive
electronics

2× USB



4-stroke engine

| | | | | | |
|--|--|---------------------|--|-------------|--|
| | displacement | 223 cm ³ | | voltage | ~230 V/12/5 V |
| | max. torque | 13 Nm | | noise level | 93 dB |
| | 12 / 230 V | 8,3 / 15,2 A | | weight | 40 kg |
| | steady electrical output | 3500 W | | tank | 12 l |
| | max. electrical output | 4000 W | | sockets | 2 × 230 V, 1 × 12 V DC, 2 × USB 5 V |
| | fuse, digital voltmeter, automatic voltage regulation, e-start, folding handle | | | | |

HECHT 2030

SMART BATTERY CHARGER



5 steps charging

Input cable: 1,5 m
Output cables: 1,5 m

| | | |
|--|---------------|--------------------|
| | power output | 6 V / 12 V (1 A) |
| | power input | 220 V / 50 Hz 20 W |
| | for batteries | 2-30 Ah |

5 charging steps, input cable: and output cables: 1,5 m, short-circuit and polarity protection

HECHT 2019

SMART BATTERY CHARGER

5 A



Winter mode
Safety Protection:
Reverse polarity
Over heat
Short Circuit
Low voltage
Over charge



| | | |
|--|---------------|-----------------------|
| | power output | 6V / 2A 12V / 1-5A |
| | power input | 230 V/50 Hz 70 W |
| | for batteries | 4-150 Ah |

weight 0,75 kg

HECHT 2013

SMART BATTERY CHARGER



15 A



| | | |
|--|---------------|-------------------|
| | power output | 12 V / 2-15 A |
| | power input | 230 V/50 Hz 200 W |
| | for batteries | 4-300 Ah |
| | weight | 1,5 kg |

6 charging steps, up to 15 A, booster - 5 mins fast charging, 12V & 6V (model 2021) socket for connecting accessories, short-circuit and polarity protection

TOOL SETS, WORK TABLES, LED LIGHTS

Leg frame profile
30 x 30 mm



HECHT 0003 FOLDABLE WORK TABLE

dimensions 60,5x62x77,5 cm
max. load capacity 100 kg
weight 5,7 kg

ACCU program 1278

Adjustable
lighting
direction



| | | | | |
|---|---------------|------------------|------------------------------|-----------------|
| ⚡ | accu Li-ion | 20 V | LEDs / light intensity | 3 W / 260 lumen |
| 🔋 | battery | 2 / 4 / 6 / 8 Ah | weight | 0,25 kg |
| 🕒 | charging time | 60 min | lighting time at full charge | 12 hrs |

HECHT 2091 WORKBENCH



dimensions 120 x 174 x 58 cm
max. load capacity 450 kg
weight 53 kg

ACCU program 1278

Adjustable
lighting
direction

36 LED



| | | | | |
|---|------------------------|------------------|------------------------------|-------------------|
| ⚡ | accu Li-ion | 20 V | lighting time at full charge | 1000 / 2000 lumen |
| 🔋 | battery | 2 / 4 / 6 / 8 Ah | weight | 0,72 kg |
| 🕒 | LEDs / light intensity | 60 min. | výkon | 20 W |

HECHT 2076 TOOL SET 76 PCS

| | | |
|------------------------|--|-----------|
| Precision screwdriver | ● 2.5 mm; ⚙️ PH0, PH00 | set (3x) |
| Screwdriver | ● 5*75, 6*100 mm; ⚙️ NO. 1*75, NO. 2*100 mm | set (4x) |
| Spinner handle | 1/4" | 1x |
| Combination pliers | 7" | 1x |
| Splitting pliers | 6" | 1x |
| Bit | 25 mm - ○ 1.5, 2, 2.5, 3, 4, 5, 5.5, 6 mm | set (8x) |
| Bit | 25 mm - ⊕ T10, T15, T20, T25, T27, T30 | set (6x) |
| Bit | 25 mm - ● 2, 3, 4, 5, 6*2, 7 mm | set (7x) |
| Bit | 25 mm - ⚙️ PH0, PH1, PH2*2, PH3 | set (5x) |
| Bit | 25 mm - ⚙️ PZ0, PZ1, PZ2*2, PZ3 | set (5x) |
| Magnetic bit holder | 60 mm | 1x |
| Ratchet handle | 3/8" | 1x |
| Combination wrench | 7, 8, 9, 10, 11, 12, 13 mm | set (7x) |
| Sockets | 3/8"-14, 15, 16, 17, 18, 19, 20, 21, 22, 24 mm | set (10x) |
| Sockets | 1/4" 6, 7, 8, 9, 10, 11, 12, 13 mm | set (8x) |
| Universal joint | 3/8" | 1x |
| Ratchet handle adaptor | 1/4" x 3/8" | 1x |
| Spinner handle adaptor | 1/4" | 1x |
| Extension bar | 3/8" - 75, 150 mm | set (2x) |
| Sliding T bar head | 3/8" x 1/2" | set (2x) |
| Spark plug socket | 3/8" 16mm | 1x |



HECHT 2094 TOOL SET 94 PCS

| | | |
|------------------------|---|-----------|
| Spark plug socket | 1/2" - 16, 21 mm | set (2x) |
| Flexible extension bar | 1/4" | 1x |
| Deep socket | 1/2" - 14, 15, 17, 19 mm | set (4x) |
| Deep socket | 1/4" - 6, 7, 8, 9, 10, 11, 12, 13 mm | set (8x) |
| Bits socket | 1/4" - ● SL 4, 5, 5.7; ⚙️ PH1, PH2; ⚙️ PZ1, PZ2; ⚙️ T8, T10, T15, T20, T25, T30; ○ H 3, 4, 5, 6 | set (17x) |
| Bit | 8*50 mm - ● SL 8, 10, 12; ⚙️ PH3, PH4; ⚙️ T40, T45, T50, T55; ○ H 8, 10, 12, 14; ⚙️ PZ3, PZ4 | set (15x) |
| Socket adaptor | 1/4" | 1x |
| Coupler | 3/8" | 1x |
| Sockets | 1/2" - 10, 11, 12, 13, 14, 15, 16, 17, 18, 19, 20, 21, 22, 23, 24, 27, 30, 32 mm | set (18x) |
| Socket | 1/4" - 4, 4.5, 5, 5.5, 6, 7, 8, 9, 10, 11, 12, 13, 14 mm | set (13x) |
| Ratchet handle | 1/4" & 1/2" | set (2x) |
| Universal joint | 1/4" & 1/2" | set (2x) |
| Extension bar | 1/4" - 2" & 4" | set (2x) |
| Spinner handle | 1/4" | 1x |
| Extension bar | 1/2" - 5" & 10" | set (2x) |
| 3-Way sliding adaptor | | 1x |
| Sliding T bar | 1/4" | 1x |
| Hex key | ● 1.5, 2, 2.5 mm | set (3x) |



HECHT 600637

MEASURING TAPE 3 M

12 pcs in packing



HECHT 2003

LASER DISTANCE MEASURER

Measurement of distances, calculation of area, calculation of volume, indirect height measurement, combined height, partial height, min/max function, addition/subtraction, 2 reference points, stake out function, storage of the last 20 results, laser technology, display with backlighting, including belt pouch, wrist strap and batteries, spirit level

Spirit level
Range max.
50 m

| | | |
|--|------------|------------------|
| | battery | 2x 1,5 V AAA |
| | weight | 88 g |
| | dimensions | 120 x 54 x 29 mm |



www.hecht.cz

HECHT 002024

INFLATOR
+ 5 M HOSE
+ 2 ADAPTORS



HECHT 002026

2 INFLATORS
+ 5 M HOSE
+ LARGE SET
OF ADAPTORS



HECHT 002075A
AIR HOSE 10M,
6.3 X 11.3 MM, PVC

max. pressure
16 bar (23°C)
quick coupler 1/4"



HECHT 002075B
SELF-WINDING DRUM
WITH PRESSURE HOSE
12 M, 5X8 MM, PU

max. pressure 10 bar
quick coupler 1/4"
inlet hose 3 m



max. pressure
16 bar (23°C)
quick coupler 1/4"

HECHT 002075C
WINDING DRUM WITH
PRESSURE HOSE 20 M,
6.3 X 11.3 MM, PVC



HECHT 002075D
pneumatic impact
wrench set

310 Nm, min 300l/min
10 pcs adaptors (9, 10, 11,
13, 14, 17, 19, 22, 24, 27 mm)
allen key and other accessories

Auto shutdown when the
preset pressure is reached

HECHT 2090
ACCU COMPRESSOR

Battery and
charger not
included

ACCU
program
1278



Digital display



Nozzles included



| | | | | | |
|--|---------------|----------------------------|--|----------------------|---------|
| | ACCU | 20 V | | weight | 1 kg |
| | battery | DC 20 V / 1x 2/4/6/8 Ah | | max. pressure | 7 bar |
| | charging time | 60 min | | no load working time | 35 min* |

COMPRESSORS

HECHT 2888 COMPRESSOR

Standard accessories:
air gun with hose
and pressure gauge,
adapter set



| | | | | | |
|-----|----------------------|---------------|---|--------------------|------------|
| ⚡ | electric | 230 V / 50 Hz | ↔ | hose | 3 m |
| ⚡ | power input | 1100 W | | number of outlets | 1 |
| ⬇⬇⬇ | max. output pressure | 8 bar | ↔ | max. suction power | 180 l/min. |

HECHT 2027 OIL COMPRESSOR



24 l

| | | | | | |
|---|--------------------|---------------|-----|----------------------|-------|
| ⚡ | electric | 230 V / 50 Hz | ⬇⬇⬇ | max. output pressure | 8 bar |
| ⚡ | power input | 1,5 kW / 2 HP | ⬆ | weight | 22 kg |
| ↔ | max. suction power | 186 l/min. | | number of outlets | 1 |
| Ⓛ | air tank volume | 24 l | | | |

HECHT 2053 OIL COMPRESSOR



50 l

| | | | | | |
|---|--------------------|---------------|-----|----------------------|-------|
| ⚡ | electric | 230 V / 50 Hz | ⬇⬇⬇ | max. output pressure | 8 bar |
| ⚡ | power input | 1,5 kW / 2 HP | ⬆ | weight | 30 kg |
| ↔ | max. suction power | 186 l/min. | | number of outlets | 2 |
| Ⓛ | air tank volume | 50 l | | | |

HECHT 2353 TWIN CYLINDER OIL COMPRESSOR



10 bar



50 l

| | | | | | |
|---|--------------------|---------------|-----|----------------------|-----------------|
| ⚡ | electric | 230 V / 50 Hz | ⬇⬇⬇ | max. output pressure | 10 bar |
| ⚡ | power input | 2,2 kW / 3 HP | ⬆ | weight | 36 kg |
| ↔ | max. suction power | 326 l/min. | | number of outlets | 2 |
| Ⓛ | air tank volume | 50 l | ⊠ | dimensions | 68 × 38 × 70 cm |

HECHT 2355 TWIN CYLINDER OIL COMPRESSOR



100 l



| | | | | | |
|---|--------------------|---------------|-----|----------------------|-------|
| ⚡ | electric | 230 V / 50 Hz | ⬇⬇⬇ | max. output pressure | 8 bar |
| ⚡ | power input | 2,2 kW / 3 HP | ⬆ | weight | 50 kg |
| ↔ | max. suction power | 316 l/min. | | number of outlets | 2 |
| Ⓛ | air tank volume | 100 l | | | |

HECHT 20171 OIL-FREE COMPRESSOR

Super silent

Oil and
maintenance-free

One outlet



6 l



| | | | | | |
|---|--------------------|---------------|-----|----------------------|-----------------|
| ⚡ | electric | 230 V / 50 Hz | ⬇⬇⬇ | max. output pressure | 8 bar |
| ⚡ | power input | 1100 W | ⬆ | weight | 17,5 kg |
| ↔ | max. suction power | 214 l/min. | | number of outlets | 1 |
| Ⓛ | air tank volume | 6 l | ⊠ | dimensions | 49 × 43 × 45 cm |



HECHT 2075
OIL-FREE
COMPRESSOR

Super silent
Oil and
maintenance-free

24 l

| | | | | | |
|---|--------------------|---------------|-----|----------------------|-----------------|
| ⚡ | electric | 230 V / 50 Hz | ⚡⚡⚡ | max. output pressure | 8 bar |
| 🔌 | power input | 750 W | 📏 | weight | 22 kg |
| ➡ | max. suction power | 132 l/min. | 🔌 | number of outlets | 1 |
| 📦 | air tank volume | 24 l | 📏 | dimensions | 59 × 28 × 61 cm |



HECHT 2086
OIL-FREE
COMPRESSOR

Super silent
Oil and
maintenance-free
Two outlets

50 l

| | | | | | |
|---|--------------------|---------------|-----|----------------------|-----------------|
| ⚡ | electric | 230 V / 50 Hz | ⚡⚡⚡ | max. output pressure | 8 bar |
| 🔌 | power input | 1500 W | 📏 | weight | 32 kg |
| ➡ | max. suction power | 264 l/min. | 🔌 | number of outlets | 2 |
| 📦 | air tank volume | 50 l | 📏 | dimensions | 76 × 32 × 62 cm |



HECHT 2089
OIL-FREE
COMPRESSOR

Very quiet
operation
Oil and
maintenance-free
2 engines

50 l

Max. suction power 528 l/min

| | | | | | |
|---|--------------------|------------------------|-----|-------------------|-------|
| ⚡ | electric | 230 V / 50 Hz | 📦 | air tank volume | 50 l |
| 🔌 | power input | 3000 W | ⚡⚡⚡ | max. pressure | 8 bar |
| 🔄 | no-load speed | 2800 min ⁻¹ | 🔌 | number of outlets | 2 |
| ➡ | max. suction power | 528 l/min. | | | |



HECHT 2084
OIL-FREE
COMPRESSOR

NEW

Very quiet
operation
Oil and
maintenance-free
2 engines

100 l

Max. suction power 528 l/min

Available from 4/25

| | | | | | |
|---|--------------------|------------------------|-----|-------------------|-------|
| ⚡ | electric | 230 V / 50 Hz | 📦 | air tank volume | 100 l |
| 🔌 | power input | 3000 W | ⚡⚡⚡ | max. pressure | 8 bar |
| 🔄 | no-load speed | 2850 min ⁻¹ | 🔌 | number of outlets | 2 |
| ➡ | max. suction power | 528 l/min. | | | |

USB charging available

HECHT 1240
SCREWDRIVER



LED light

Rotary handle

USB charging available

HECHT 1241
SCREWDRIVER



Magnetic bit holder

LED light

52 × bit
1 × bit holder

Case included

Rotary handle

Flash light

| | | | | | |
|---|---------------|----------------|---|---|--------|
| ⚡ | ACCU | 3,6 V | 🔄 | max. torque | 4 N.m |
| 🔌 | battery | Li-ion, 1,5 Ah | 📏 | weight | 0,3 kg |
| 🔄 | no load speed | 230 rpm | | 2 bits, integrated battery, charger (3-5 h) | |

| | | | | | |
|---|---------------|--------------|---|--|--------|
| ⚡ | ACCU | 3,7 V | 🔄 | max. torque | 4 N.m |
| 🔌 | battery | Li-ion, 2 Ah | 📏 | weight | 0,3 kg |
| 🔄 | no load speed | 230 rpm | | 52 bits, integrated battery, charger (3-5 h) | |

CORDLESS POWER TOOLS

Double speed gearbox

HECHT 1242 SCREWDRIVER



LED light

- battery and charger included
- 1 x battery HECHT 001242

HECHT 001242
BATTERY 1,5 AH
for HECHT 1242

| | | | | |
|---|---------------|------------------|----------------|--------|
| ⚡ | ACCU | 12 V | chuck capacity | 10 mm |
| 🔋 | battery | LI-ion, 1,5 Ah | ⚙️ max. torque | 22 N.m |
| 🌀 | no load speed | 0-350/0-1300 rpm | 👤 weight | 1 kg |

2 speed, battery, charger (3-5 h)

Double speed gearbox

HECHT 1245 DRILL



LED light

- quick charger 1 h
- charging indicator
- 1 x battery HECHT 001245B

HECHT 001245B
BATTERY 1,5 AH
for HECHT 1245

| | | | | |
|---|---------------|------------------|----------------|---------|
| ⚡ | ACCU | 16 V | chuck capacity | 1-10 mm |
| 🔋 | battery | LI-ion, 1,5 Ah | ⚙️ max. torque | 30 N.m |
| 🌀 | no load speed | 0-400/0-1300 rpm | 👤 weight | 1,5 kg |

2 speed, battery, quick charger (1 h), charging indicator

Double speed gearbox

HECHT 1247 DRILL



LED light

- quick charger 1 h
- charging indicator
- 1 x battery HECHT 001246

HECHT 001246
BATTERY 2 AH
for HECHT 1247

| | | | | |
|---|---------------|------------------|----------------|---------|
| ⚡ | ACCU | 20 V | chuck capacity | 1-10 mm |
| 🔋 | battery | LI-ion, 2 Ah | ⚙️ max. torque | 40 N.m |
| 🌀 | no load speed | 0-400/0-1400 rpm | 👤 weight | 1,5 kg |

2 speed, battery, quick charger (1 h)

Double speed gearbox

HECHT 1277 IMPACT DRILL



LED light



Case included

- quick charger 1 h
- charging indicator
- 2 x battery HECHT 001277BX

ACCU program 1278

| | | | | |
|---|---------------|--------------------------|----------------|-----------|
| ⚡ | ACCU | 20 V | chuck capacity | 0,8-10 mm |
| 🔋 | battery | DC 20 V / 1 x 2/4/6/8 Ah | ⚙️ max. torque | 30 N.m |
| 🌀 | no load speed | 0-350/0-1250 rpm | 👤 weight | 1,4 kg |

2 speed, 2x battery, quick charger (1 h), 6 pcs screw bits, 6 pcs drill bits, magnetic bit holder, plastic carrying case, electric brake

Double speed gearbox

HECHT 1278 IMPACT DRILL



LED light



Case included

- quick charger 1 h
- charging indicator
- 2 x battery HECHT 001277BX

ACCU program 1278

| | | | | |
|----|---------------|--------------------------|----------------|---------------|
| ⚡ | ACCU | 20 V | chuck capacity | 2-13 mm |
| 🔋 | battery | DC 20 V / 1 x 2/4/6/8 Ah | 🔨 impact rate | 0-525/0-18750 |
| 🌀 | no load speed | 0-350/0-1250 rpm | 👤 weight | 1,54 kg |
| ⚙️ | max. torque | 35 N.m | | |

2 speed, 2x battery, quick charger (1 h), 6 pcs screw bits, 6 pcs drill bits, magnetic bit holder, plastic carrying case, electric brake

PROFI TOOL

Double speed gearbox

HECHT 1289 IMPACT DRILL



LED light



Case included

- quick charger 1 h
- charging indicator
- 2 x battery HECHT 001277BX

Brushless motor

| | | | | |
|----|---------------|--------------------------|----------------|----------------|
| ⚡ | ACCU | 20 V | chuck capacity | 2-13 mm |
| 🔋 | battery | DC 20 V / 1 x 2/4/6/8 Ah | 🔨 impact rate | 0-7500/0-25500 |
| 🌀 | no load speed | 0-500/0-1700 rpm | 👤 weight | 1,49 kg |
| ⚙️ | max. torque | 50 N.m | | |

2 speed, 2x battery, quick charger (1 h), 6 pcs screw bits, 6 pcs drill bits, magnetic bit holder, plastic carrying case, metal chuck, long life brushless motor, electric brake

PROFI TOOL



HECHT 1256
IMPACT WRENCH

ACCU program 1278

3 torque options
120/180/300 Nm

Available from 3/25

Long life brushless motor

| | | | | |
|----|---------------|--------------------------|------------------------------------|---------|
| ⚡ | ACCU | 20 V | chuck capacity | 1/2" |
| 🔋 | battery | Li-ion, 2/4/6/8 Ah | ⚙️ max. torque | 300 N.m |
| 🔄 | no load speed | 0-2700 rpm | 📏 weight | 1,6 kg |
| ⚙️ | impact rate | 0-3780 min ⁻¹ | 🚫 Battery and charger not included | |
| 🕒 | charging time | 60 min | 🕒 working time | 40 min* |

HECHT 1070
IMPACT DRILL



650 W

| | | | | |
|----|---------------|---------------------------|---------------------------|--------|
| ⚡ | electric | 230 V/50 Hz | drilling capacity - steel | 13 mm |
| 🔋 | power input | 650 W | max. chuck size | 13 mm |
| 🔄 | no load speed | 0-3000 rpm | 📏 weight | 1,8 kg |
| ⚙️ | impact rate | 0-48000 min ⁻¹ | | |

variable speed, auxiliary handle, depth gauge, key chuck

HECHT 1072
IMPACT DRILL



900 W

| | | | | |
|----|---------------|---------------------------|---------------------------|---------|
| ⚡ | electric | 230 V/50 Hz | drilling capacity - steel | 13 mm |
| 🔋 | power input | 900 W | max. chuck size | 13 mm |
| 🔄 | no load speed | 0-3000 min ⁻¹ | 📏 weight | 2,05 kg |
| ⚙️ | impact rate | 0-48000 min ⁻¹ | | |

✓ variable speed, auxiliary handle, depth gauge, keyless chuck

HECHT 1077
IMPACT DRILL



1200 W

Aluminium alloy 2 speed gearbox

| | | | | |
|----|---------------|-------------|---------------------------|---------------------------|
| ⚡ | electric | 230 V/50 Hz | drilling capacity - steel | 13 mm |
| 🔋 | power input | 1200 W | max. chuck size | 13 mm |
| 🔄 | no load speed | 0-1000 rpm | 📏 weight | 3,6 kg |
| ⚙️ | no load speed | 0-2800 rpm | ⚙️ impact rate | 0-44800 min ⁻¹ |

variable speed, auxiliary handle, depth gauge

HECHT 1082
ROTARY HAMMER



SDS PLUS

2,4 J
800 W

| | | | | |
|----|---------------|-------------|------------------------------|--------|
| ⚡ | electric | 230 V/50 Hz | drilling capacity - steel | 13 mm |
| 🔋 | power input | 800 W | drilling capacity - concrete | 24 mm |
| 🔄 | no load speed | 0-1470 rpm | ⚡ impact power | 2,4 J |
| ⚙️ | impact rate | 0-5100 rpm | 📏 weight | 2,3 kg |

📌 SDS plus drive, auxiliary handle, 1pc point chisel, 1 pc flat chisel, 3 drill bits, key

SDS PLUS

HECHT 1028
ROTARY HAMMER



4,5 J
1050 W

| | | | | |
|----|---------------|-------------|------------------------------|----------|
| ⚡ | electric | 230 V/50 Hz | tool holder | SDS plus |
| 🔋 | power input | 1050 W | drilling capacity - concrete | 26 mm |
| 🔄 | no load speed | 950 rpm | ⚡ impact power | 4,5 J |
| ⚙️ | impact rate | 4250 rpm | 📏 weight | 4,5 kg |

📌 SDS plus drive, auxiliary handle, 1pc point chisel 14x250mm, 1 pc flat chisel 14x250mm, 3 drill bits-8/10/12x150mm, depth gauge, wrench, plastic carrying case

CORDLESS POWER TOOLS, POWER TOOLS

SDS PLUS

HECHT 1036 ROTARY HAMMER

SDS MAX

HECHT 1069 ROTARY HAMMER

Model 2023



6 J

1500 W



9 J

1600 W



| | | | | |
|----|---------------|-------------|------------------------------|----------|
| ⚡ | electric | 230 V/50 Hz | tool holder | SDS plus |
| ⚡ | power input | 1500 W | drilling capacity - concrete | 32 mm |
| ⚙️ | no load speed | 860 rpm | impact power | 6 J |
| ⚙️ | impact rate | 4250 rpm | weight | 5,2 kg |

SDS plus drive, auxiliary handle, 2 pcs chisel, 3 pcs drill bit, dust cover, wrench, plastic carrying case

| | | | | |
|----|---------------|-------------|------------------------------|---------|
| ⚡ | electric | 230 V/50 Hz | tool holder | SDS max |
| ⚡ | power input | 1600 W | drilling capacity - concrete | 40 mm |
| ⚙️ | no load speed | 560 rpm | impact power | 10 J |
| ⚙️ | impact rate | 3800 rpm | weight | 7,3 kg |

SDS max drive, auxiliary handle, 1pc point chisel 18x320mm, 1 pc drill bit 18x320mm, wrench, plastic carrying case

SDS MAX

HECHT 1090 DEMOLITION HAMMER

PROFI TOOL

HECHT 1093 DEMOLITION HAMMER

SDS-HEX

60 J

1700 W



15 J

1300 W



Available
from 2/25

| | | | | |
|----|-------------|-------------|--------------|---------|
| ⚡ | electric | 230 V/50 Hz | tool holder | SDS max |
| ⚡ | power input | 1300 W | impact power | 15 J |
| ⚙️ | impact rate | 3600 rpm | weight | 7,2 kg |

SDS max drive, auxiliary handle, 2 pcs chisel, 1 pc lubricant, plastic carrying case

| | | | | |
|----|-------------|------------------------|--------------|---------|
| ⚡ | electric | 230 V/50 Hz | tool holder | SDS-HEX |
| ⚡ | power input | 1700 W | impact power | 60 J |
| ⚙️ | impact rate | 1900 min ⁻¹ | weight | 14,9 kg |

✓ SDS-HEX mounting, additional handle, 1x pointed chisel, 1x flat chisel, 1x lubricant, carbon brush, plastic carrying case



PROFI TOOL

HECHT 1023 ACCU ROTARY HAMMER

ACCU
program
1278

4,5 J

BRUSHLESS
MOTOR

Battery and
charger not
included



| | | | | |
|----|---------------|----------------------------|------------------------------|----------|
| ⚡ | ACCU | 20 V | chuck capacity | 14 mm |
| ⚡ | battery | DC 20 V / 1x 2/4/6/8 Ah | impact rate | 4350 bpm |
| ⚙️ | no load speed | 950 rpm | drilling capacity - concrete | 26 mm |
| ⚙️ | impact power | 4,5 J | weight | 3,8 kg |

6 pcs drill bits, 2 pcs chisels, plastic carrying case, depth gauge, dust cover



* Maximum working time without load with 2 Ah battery.

CORDLESS POWER TOOLS, POWER TOOLS



60 cm

HECHT 1055 DRILL PRESS

HECHT 001055

Vise for HECHT 1055
and 1063
2,5"



Quality
gearbox



84 cm

HECHT 1063 DRILL PRESS

Powerful
motor 600 W

Quality
gearbox

| | | | | |
|---|---------------|--------------|-----------------|-------|
| ⚡ | electric | 230 V/50 Hz | lift height | 50 mm |
| 🔋 | power input | 500 W | chuck capacity | 16 mm |
| 🌀 | no load speed | 420-2700 rpm | number of gears | 9 |
| 👤 | weight | 15 kg | | |

| | | | | |
|---|---------------|--------------|-----------------|-------|
| ⚡ | electric | 230 V/50 Hz | lift height | 60 mm |
| 🔋 | power input | 600 W | chuck capacity | 16 mm |
| 🌀 | no load speed | 420-2700 rpm | number of gears | 12 |
| 👤 | weight | 30 kg | | |



HECHT 1515 ACCU NAILER



750 W



HECHT 1545 JIG SAW

500 W

www.hecht.cz

Available
from 5/25

| | | | | |
|---|-------------------|-------------------------|------------------------------|-----------------|
| ⚡ | ACCU | 20 V | U-stapler / T-nailer | 19-40 / 20-50mm |
| 🔋 | battery | DC 20 V / 1x 2/4/6/8 Ah | max. firing speed per minute | 100 |
| | magazine capacity | 100 pcs | 👤 weight | 2,8 kg |

200 pcs U-nails & 200 pcs T-nails included in package

| | | | | |
|---|---------------|-------------|-----------------------|---------|
| ⚡ | electric | 230 V/50 Hz | cutting depth - wood | 55 mm |
| 🔋 | power input | 500 W | cutting depth - steel | 6 mm |
| 🌀 | no load speed | 0-3000 rpm | 👤 weight | 1,21 kg |

With saw blade, hex key



HECHT 1560 JIG SAW



HECHT 1561 JIG SAW

| | | | | |
|---|---------------|-------------|-----------------------|--------|
| ⚡ | electric | 230 V/50 Hz | cutting depth - wood | 65 mm |
| 🔋 | power input | 650 W | cutting depth - steel | 10 mm |
| 🌀 | no load speed | 0-3100 rpm | 👤 weight | 1,5 kg |

with saw blade, dust adaptor

| | | | | |
|---|---------------|-------------|-----------------------|--------|
| ⚡ | electric | 230 V/50 Hz | cutting depth - wood | 80 mm |
| 🔋 | power input | 800 W | cutting depth - steel | 10 mm |
| 🌀 | no load speed | 0-3100 rpm | 👤 weight | 1,5 kg |

with saw blade, guide fence

ACCU
program
1278

HECHT 1531 ACCU JIG SAW



Quick-release
blade guard

| | | | | |
|---|---------------|--------------------------|------------------------|---------|
| ⚡ | ACCU | 20 V DC | cutting depth - wood | 80 mm |
| 🔋 | battery | Li-ion, 2/4/6/8 Ah | cutting depth - steel | 10 mm |
| 🌀 | no load speed | 0-2400 min ⁻¹ | 🏋️ weight | 1,7 kg |
| 🕒 | charging time | 60 min | 🕒 no load working time | 30 min* |

Battery and charger not included

HECHT 1307 ANGLE GRINDER



650 W

| | | | | |
|---|---------------|---------------|-----------------|--------|
| ⚡ | electric | 230 V / 50 Hz | disc diameter | 115 mm |
| 🔋 | power input | 650 W | sprindle thread | M14 |
| 🌀 | no load speed | 12000 rpm | 🏋️ weight | 1,8 kg |

auxiliary handle, wrench, the grindstone is not included

Quick-release
disc guard

HECHT 1392 ANGLE GRINDER



950 W

| | | | | |
|---|---------------|-------------|-----------------|--------|
| ⚡ | electric | 230 V/50 Hz | disc diameter | 125 mm |
| 🔋 | power input | 950 W | sprindle thread | M14 |
| 🌀 | no load speed | 12000 rpm | 🏋️ weight | 2,3 kg |

auxiliary handle, wrench, the grindstone is not included

Quick-release
disc guard

HECHT 1310 ANGLE GRINDER



1200 W

| | | | | |
|---|---------------|-------------|-----------------|--------|
| ⚡ | electric | 230 V/50 Hz | disc diameter | 125 mm |
| 🔋 | power input | 1200 W | sprindle thread | M14 |
| 🌀 | no load speed | 12000 rpm | 🏋️ weight | 2,5 kg |

auxiliary handle, wrench, the grindstone is not included

Quick-release
disc guard

HECHT 1324 HECHT 1320 ANGLE GRINDER ACCU ANGLE GRINDER



2200 W

| | | | | |
|---|---------------|-------------|-----------------|--------|
| ⚡ | electric | 230 V/50 Hz | disc diameter | 230 mm |
| 🔋 | power input | 2200 W | sprindle thread | M14 |
| 🌀 | no load speed | 6500 rpm | 🏋️ weight | 5,5 kg |

auxiliary handle, wrench, the grindstone is not included

ACCU
program
1278



| | | | | |
|---|---------------|------------------------|------------------------|---------|
| ⚡ | ACCU | 20 V DC | disc diameter | 115 mm |
| 🔋 | battery | Li-ion, 2/4/6/8 Ah | sprindle thread | M14 |
| 🌀 | no load speed | 1000 min ⁻¹ | 🏋️ weight | 1,7 kg |
| 🕒 | charging time | 60 min | 🕒 no load working time | 20 min* |

Battery and charger not included

* Maximum working time without load with 2 Ah battery.

HECHT 1722 BENCH GRINDER



150 W

| | | | | |
|--|---------------|------------------------|----------------------|---------------|
| | electric | 230 V/50 Hz | disc diameter | 150 mm |
| | power input | 150 W | grinding wheel grain | K60+K36 |
| | no load speed | 2950 min ⁻¹ | | weight 4,8 kg |

HECHT 1723 BENCH GRINDER



350 W

| | | | | |
|--|---------------|------------------------|----------------------|---------------|
| | electric | 230 V/50 Hz | disc diameter | 200 mm |
| | power input | 350 W | grinding wheel grain | K60+K36 |
| | no load speed | 2950 min ⁻¹ | | weight 9,5 kg |

HECHT 1660 WALL CHASER

1600 W



| | | | | |
|--|---------------|-------------|----------------|---------|
| | electric | 230 V/50 Hz | cutting depth | 5–30 mm |
| | power input | 1600 W | cutting width | 8–30 mm |
| | no load speed | 9000 rpm | blade diameter | 125 mm |

soft start, anti-slip grip, 2 diamond blades, 1 spanner, 1 chisel, 1 dust tube

001176660
SANDPAPER
roughness 60, 10 pcs

001176680
SANDPAPER
roughness 80, 10 pcs

001176620
SANDPAPER
roughness 120, 10 pcs

HECHT 1766 FINISHING SANDER



200 W

| | | | | | |
|--|---------------|-------------|--|----------------|-------------------|
| | electric | 230 V/50 Hz | | baseboard size | 140 × 140 × 80 mm |
| | power input | 200 W | | weight | 1,6 kg |
| | no load speed | 15500 rpm | | | |

sandpaper, plastic dust container

001176760
SANDPAPER
10 pcs, roughness 60

001176780
SANDPAPER
10 pcs, roughness 80

001176720
SANDPAPER
10 pcs, roughness 120



220 W

| | | | | | |
|--|---------------|-------------|--|----------------|-------------|
| | electric | 230 V/50 Hz | | baseboard size | 187 × 90 mm |
| | power input | 220 W | | weight | 1,65 kg |
| | no load speed | 12000 rpm | | | |

sandpaper, plastic dust container

HECHT 1767 FINISHING SANDER

001176860
SANDPAPER
10 pcs, roughness 60

001176880
SANDPAPER
10 pcs, roughness 80

001176820
SANDPAPER
10 pcs, roughness 120

HECHT 1768 ORBITAL SANDER



450 W

| | | | | | |
|--|---------------|-------------|--|----------------|----------|
| | electric | 230 V/50 Hz | | baseboard size | Ø 125 mm |
| | power input | 450 W | | weight | 2 kg |
| | no load speed | 13000 rpm | | | |

sandpaper, plastic dust container

0001781060
SANDPAPER
5 pcs, 533×76 mm,
roughness 60

0001781080
SANDPAPER
5 pcs, 533×76 mm,
roughness 80

0001781120
SANDPAPER
5 pcs, 533×76 mm,
roughness 120



HECHT 1781 BELT SANDER

Adjustable speed



| | | | | |
|----|---------------|-------------|--------------|-------------|
| ⚡ | electric | 230 V/50 Hz | sanding size | 140 X 76 mm |
| ⚡ | power input | 810 W | sanding belt | 533 x 76 mm |
| ⚙️ | no load speed | 380 rpm | weight | 3,2 kg |

sanding belt, dust bag

HECHT 001790
UPSIDE DOWN TABLE
FOR HECHT 1790



HECHT 1790 PLANER

900 W



| | | | | |
|----|---------------|-------------|--|-------|
| ⚡ | electric | 230 V/50 Hz | max. planing width | 82 mm |
| ⚡ | power input | 900 W | max. planing depth | 3 mm |
| ⚙️ | no load speed | 16000 rpm | max. rebating depth | 15 mm |
| ⚖️ | weight | 2,8 kg | with accessories box (key, allen key), guide fence | |

HECHT 1795 TOP MILLING TOOL

HECHT 001795
SET OF MILLING
BITS - 12 ks



1200 W

| | | | | |
|----|---|-------------------------------|---------------|--------|
| ⚡ | electric | 230 V/50 Hz | cutting depth | 55 mm |
| ⚡ | power input | 1200 W | collet hole | 6/8 mm |
| ⚙️ | no load speed | 11000-30000 min ⁻¹ | | |
| ✓ | 1,85 supply cable, 2× guide rail, ruler, dust extraction adapter, collet chuck (pre-assembled), centering pin | | | |

HECHT 1572 RECIPROCATING SAW

710 W



Blade for wood and steel included

| | | | | |
|----|---------------|--------------------------|-----------------------|--------|
| ⚡ | electric | 230 V/50 Hz | cutting depth – wood | 115 mm |
| ⚡ | power input | 710 W | cutting depth – steel | 5 mm |
| ⚙️ | no load speed | 0-2800 min ⁻¹ | weight | 2,4 kg |

AVAILABLE ACCESSORIES



STANDARD ACCESSORIES

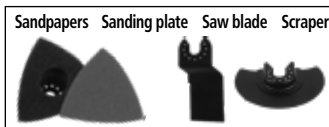

300 W

HECHT 1632 OSCILLATING MULTI-TOOL

Adjustable speed



Quick release guard

| | | | | |
|--|-------------|-------------|----------------------------------|-------------------|
| ⚡ | electric | 230 V/50 Hz | Quick Change Multi-function Tool | |
| ⚡ | power input | 300 W | no load speed | 15000 - 22000 rpm |
| 1pc saw blade, 1pc spade, 1pc sandpaper fixing plate, 1pc sandpaper for metal, 1pc sandpaper for wood, plastic carrying case | | | | |

HECHT 1575 RECIPROCATING SAW

1050 W



Power Indicator

Blade for wood and steel included

| | | | | |
|----|---------------|--------------------------|-----------------------|--------|
| ⚡ | electric | 230 V/50 Hz | cutting depth – wood | 150 mm |
| ⚡ | power input | 1050 W | cutting depth – steel | 10 mm |
| ⚙️ | no load speed | 0-2500 min ⁻¹ | weight | 3,4 kg |

ACCU
program
1278

HECHT 1510 ACCU RECIPROCATING SAW



Quick blade change system

| | | | | |
|---|----------------------|--------------------------|----------------------------------|-------|
| ⚡ | Accu Li-Ion | DC 20 V / 1 × 2/4/6/8 Ah | cutting depth – steel | 10 mm |
| 🌀 | no load speed | 0-3000 min ⁻¹ | 👤 weight | 2 kg |
| 📏 | cutting depth - wood | 115 mm | Battery and charger not included | |

1200 W

HECHT 1613 CIRCULAR SAW



**HECHT 001613
SAW BLADE**
for HECHT 1613, 1624, 1626
ø 185 mm

| | | | | |
|-----------------------------|---------------|------------------------|--------------------|--------|
| ⚡ | electric | 230 V/50 Hz | blade diameter | 185 mm |
| 🔌 | power input | 1200 W | max. cutting depth | 65 mm |
| 🌀 | no load speed | 5500 min ⁻¹ | 👤 weight | 3,7 kg |
| with saw blade, guide fence | | | | |

www.hecht.cz

1500 W

HECHT 1627 CIRCULAR SAW



Laser

| | | | | |
|---|--------------------------------|------------------------|----------------------|--------|
| ⚡ | electric | 230 V /50 Hz | 📏 blade diameter | 185 mm |
| 🔌 | power input | 1500 W | 📏 max. cutting depth | 63 mm |
| 🌀 | no load speed | 4700 min ⁻¹ | 👤 weight | 4,3 kg |
| ✓ | pilový kotouč, vodící pravítko | | | |

Power indicator

HECHT 1620 CIRCULAR SAW



Laser

1800 W

| | | | | |
|---|--------------------------------|------------------------|----------------------|--------|
| ⚡ | electric | 230 V /50 Hz | 📏 blade diameter | 210 mm |
| 🔌 | power input | 1800 W | 📏 max. cutting depth | 73 mm |
| 🌀 | no load speed | 5000 min ⁻¹ | 👤 weight | 6,4 kg |
| ✓ | pilový kotouč, vodící pravítko | | | |

ACCU
program
1278

HECHT 1670 ACCU CIRCULAR SAW



**HECHT 001670
SAW BLADE FOR WOOD**
24T, 150×10×1,6 mm



Laser

| | | | | |
|----------------------------------|---------------|--------------------------|------------------------|---------|
| ⚡ | accu | 20 V DC | blade diameter | 150 mm |
| 🔌 | battery | DC 20 V / 1 × 2/4/6/8 Ah | cutting depth | 48 mm |
| 🌀 | no load speed | 0-4200 min ⁻¹ | 👤 weight | 2,37 kg |
| 🕒 | charging time | 60 min | 🕒 no load working time | 35 min* |
| Battery and charger not included | | | | |

HECHT 813 MITRE SAW WITH AC LASER



SAW BLADE
48T×210 mm×25,4 mm
for HECHT 814, 818, 828, 813
nr.: HECHT 00828

1400 W



Laser

| | | | | |
|---|---------------|------------------------|-----------------|-----------------|
| ⚡ | electric | 230 V/50 Hz | 📏 tilting range | -45° / 0° / 45° |
| 🔌 | power input | 1400 W | 📏 mitre cuts | 90°-45° left |
| 📏 | saw blade | ø 210 mm | 👤 weight | 6,3 kg |
| 🌀 | no load speed | 5000 min ⁻¹ | | |

ANGLE / CUT

| | |
|-----------|-------------|
| 90° × 90° | 55 × 120 mm |
| 45° × 45° | 30 × 83 mm |
| 45° × 90° | 30 × 120 mm |
| 90° × 45° | 55 × 83 mm |

2000 W

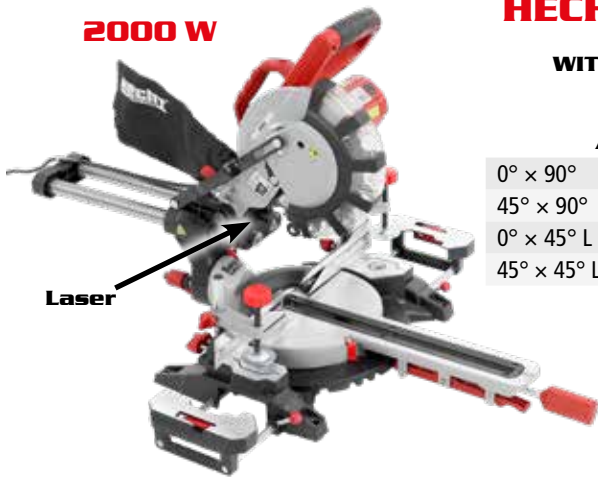

HECHT 829
MITRE SAW
WITH AC LASER

ANGLE / CUT

| | |
|-------------|-------------|
| 0° × 90° | 65 × 340 mm |
| 45° × 90° | 65 × 240 mm |
| 0° × 45° L | 38 × 340 mm |
| 45° × 45° L | 38 × 240 mm |

Laser

| | | | | | |
|----|---------------|------------------------|---|---------------|-------------------------|
| ⚡ | electric | 230 V/50 Hz | ↕ | tilting range | -45° / 0° |
| ⚡ | power input | 2000 W | ↕ | mitre cuts | 90°-45° right + left |
| ⚙️ | saw blade | ø 210 mm | 👤 | weight | 12,2 kg |
| 🌀 | no load speed | 4800 min ⁻¹ | | | |

2350 W

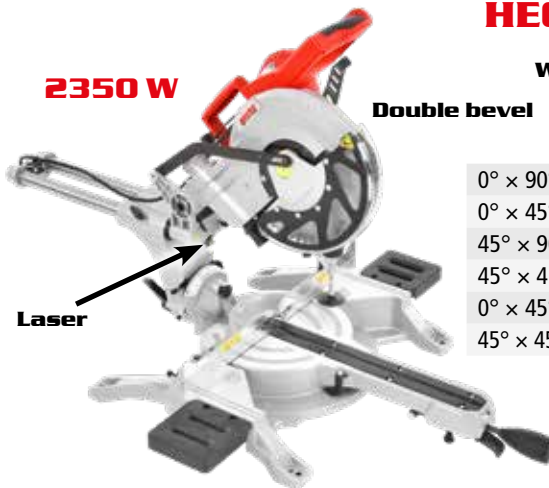

HECHT 820
MITRE SAW
WITH AC LASER

Double bevel

ANGLE / CUT

| | |
|-------------|--------------|
| 0° × 90° | L75 × 340 mm |
| 0° × 45° | L45 × 340 mm |
| 45° × 90° | L75 × 240 mm |
| 45° × 45° | L45 × 240 mm |
| 0° × 45° R | 25 × 340 mm |
| 45° × 45° R | 25 × 240 mm |

Laser

| | | | | | |
|----|---------------|------------------------|---|---------------|-------------------------|
| ⚡ | electric | 230 V/50 Hz | ↕ | tilting range | -45° / 0° / 45° |
| ⚡ | power input | 2350 W | ↕ | mitre cuts | 90°-45° right + left |
| ⚙️ | saw blade | ø 255 mm | 👤 | weight | 18 kg |
| 🌀 | no load speed | 4200 min ⁻¹ | | | |

HECHT 8254
BENCH SAW



HECHT 008254
SAW BLADE
for HECHT 8254
ø 254 mm × ø 30 mm × 48T



CUT DEPTH

| | |
|-----|-------|
| 90° | 85 mm |
| 45° | 65 mm |

2000 W

| | | | | | |
|----|---------------|------------------------|---|--------------|-------------------------|
| ⚡ | electric | 230 V / 50 Hz | 🐎 | table height | 829 mm |
| ⚡ | power input | 2000 W | ↕ | mitre cuts | 90°-45° right + left |
| ⚙️ | saw blade | ø 250 mm | 👤 | weight | 19 kg |
| 🌀 | no load speed | 5000 min ⁻¹ | | | |

HECHT 8751
JOINTER
AND PLANER



1250 W

HECHT 008751
SPARE KNIVES
for HECHT 8751 (2 pcs)

| | | | | | |
|---|---------------|------------------------|---|--|--------------------------------|
| ⚡ | electric | 230 V / 50 Hz | 🐎 | table dimensions planing / stretching | 740 × 210 mm / 250 × 204 mm |
| ⚡ | power input | 1250 W | 📏 | max. cutting width | 204 mm |
| 📏 | cutting depth | 0-2 mm | 🔌 | length of the supply cable | 200 cm |
| 🌀 | no load speed | 8000 min ⁻¹ | 👤 | weight | 21 kg |

HECHT 8916
SCROLL SAW



HECHT 008916
SAW BLADE
for HECHT 8916
5 pcs/package

120 W

| | | | | | |
|---|-----------------|----------------------------|---|--------------|------------|
| ⚡ | electric | 230 V / 50 Hz | ↔ | blade length | 127 mm |
| ⚡ | power input | 120 W | | stroke | 19 mm |
| 🐎 | throat capacity | 406 mm | 🐎 | table size | 255×415 mm |
| 🌀 | stroke speed | 400-1650 min ⁻¹ | 👤 | weight | 13 kg |

HECHT 8925
BAND SAW



HECHT 008925
SAW BLADE
FOR HECHT 8925

250 W

| | | | | | |
|---|------------------|------------------------|---|------------------|-------|
| ⚡ | electric | 230 V/50 Hz | 📏 | cut depth at 90° | 80 mm |
| ⚡ | power input | 250 W | 📏 | cut depth at 45° | 45 mm |
| ↔ | saw blade length | 1400 mm | 👤 | weight | 17 kg |
| 🌀 | no load speed | 1487 min ⁻¹ | | | |

* Maximum working time without load with 2 Ah battery.

HECHT 008950

SAW BLADE FOR
HECHT 8950



500 W



HECHT 8950 BAND SAW

HECHT 008950A

STAND FOR
HECHT 8950



| | | | | | |
|--|------------------|------------------------|--|------------------|------------|
| | electric | 230 V/50 Hz | | cut depth at 90° | 115 mm |
| | power input | 500 W | | cut depth at 45° | 65 mm |
| | saw blade length | 1712 mm | | table size | 302x304 mm |
| | no load speed | 2982 min ⁻¹ | | weight | 24 kg |

2600 W

HECHT 835 CUT OFF SAW



HECHT 00835

SAW BLADE
FOR HECHT 834



| | | | | | |
|--|---------------|------------------------|--|----------------|-------------|
| | electric | 230 V/50 Hz | | blade diameter | 355 mm |
| | power input | 2600 W | | mitre cuts | -30° - +45° |
| | no load speed | 4100 min ⁻¹ | | weight | 12,3 kg |

HECHT 8400 ELECTRIC WOOD LATHE

Accessories for HECHT 8410

HECHT 008410A
Lathe knife set 8x8 mm

HECHT 008410B
Swivel tip MT2

HECHT 008410C
Clamping disc Ø 160 mm

HECHT 008410D
Clamping set for disc Ø 160 mm

HECHT 008410E
4-jaw chuck 100 mm

HECHT 008410F
Fixed bezel

HECHT 008410G
Sliding bezel

HECHT 008410H
Fixed tip MT3

HECHT 008410I
Drill chuck 13mm + MT2

HECHT 8410 ELECTRIC MINI LATHE



Accessories included

400 W

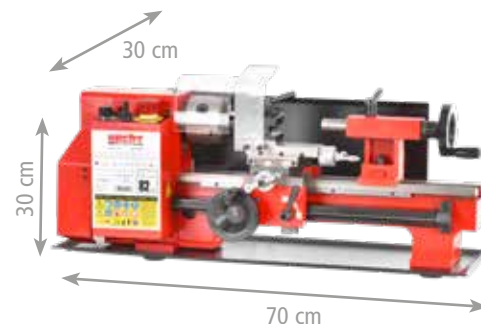

370 W

Standard accessories included

| | | | | | |
|--|---------------|--|--|----------------------------------|---------------|
| | electric | 230 V/50 Hz | | spindle head thread | M18 |
| | power input | 400 W | | max. workpiece length / diameter | 1000 / 350 mm |
| | no load speed | 890/1260/ 1760/2600 min ⁻¹ | | weight | 21 kg |

| | | | | | |
|--|---------------|--|--|--------------------------------------|------------|
| | electric | 230 V/50 Hz | | swing over bed | 180 mm |
| | power input | 250 W | | distance between centers | 300 mm |
| | no load speed | 100-1100 min ⁻¹ , 100-2500 min ⁻¹ | | cross slide travel / compound travel | 65 / 55 mm |
| | spindle taper | MT2, MT3 | | weight | 37 kg |

Accessories for HECHT 8420

HECHT 008420A
Lathe knife set 10x10mm

HECHT 008420B
Swivel tip MT2

HECHT 008420C
Clamping disc Ø 220 mm

HECHT 008420D
Clamping set for disc Ø 220 mm

HECHT 008420E
Fixed bezel

HECHT 008420F
Sliding bezel

HECHT 008420G
Sliding bezel

HECHT 008420H
Sliding bezel

HECHT 8420 ELECTRIC BENCH LATHE



960 W

Standard accessories included

| | | | | | |
|--|---------------------------|----------------------------|--|--------------------------------------|-------------|
| | electric | 230 V/50 Hz | | swing over bed | 250 mm |
| | power input | 550 W | | distance between centers | 550 mm |
| | no load speed | 125-2000 min ⁻¹ | | cross slide travel / compound travel | 110 / 75 mm |
| | spindle / tailstock taper | MT2 / MT3 | | weight | 145 kg |

HECHT 900255 WELDING SHIELD

Welding + grinding
function



| | | | | | |
|--|--|-------------|--|------------------|--------------|
| | filter size | 110 × 90 mm | | UV / IR | DIN 16 |
| | window dimensions | 92 × 42 mm | | dark state shade | DIN 9-DIN 13 |
| | response time | ≤ 1/25000 s | | weight | 0,5 kg |
| | solar cells + battery, sensitivity control, fully automatic on/off | | | | |

WELDERS, POWER TOOLS

HECHT 1824 MMA ELECTRODE WELDER - INVERTOR

140 A



| | | | | | |
|---|-----------------|----------|---|--------------------------------|----------|
| ⚡ | input capacity | 5,1 kVA | ∅ | electrode diameter | 1–3,2 mm |
| ⚡ | welding current | 20–140 A | ⚖ | weight | 3,4 kg |
| ⚡ | welding voltage | 25,6 V | ⚡ | efficiency | 70 % |
| ⚡ | duty cycle | 40 % | ✓ | electrode holder, ground clamp | |

HECHT 1826 MMA ELECTRODE WELDER - INVERTOR

160 A



| | | | | | |
|---|-----------------|----------|---|--------------------------------|--------|
| ⚡ | input capacity | 6 kVA | ∅ | electrode diameter | 1–4 mm |
| ⚡ | welding current | 20–160 A | ⚖ | weight | 4,2 kg |
| ⚡ | welding voltage | 26,4 V | ⚡ | efficiency | 70 % |
| ⚡ | duty cycle | 40 % | ✓ | electrode holder, ground clamp | |

HECHT 1828 MMA ELECTRODE WELDER - INVERTOR

180 A



| | | | | | |
|---|-----------------|----------|---|--------------------------------|--------|
| ⚡ | input capacity | 7 kVA | ∅ | electrode diameter | 1–4 mm |
| ⚡ | welding current | 20–180 A | ⚖ | weight | 4,6 kg |
| ⚡ | welding voltage | 27,2 V | ⚡ | efficiency | 70 % |
| ⚡ | duty cycle | 40 % | ✓ | electrode holder, ground clamp | |

HECHT 1830 MMA, MIG, MAG WELDER INVERTOR

200 A

Available from 2/25



| | | | | | |
|---|-----------------|----------|---|-----------------------|----------|
| ⚡ | input capacity | 6,9 kVA | ⚡ | welding wire diameter | 0.8+1 mm |
| ⚡ | welding current | 20–200 A | ∅ | electrode diameter | 1–4 mm |
| ⚡ | welding voltage | 27,2 V | ⚖ | weight | 5 kg |
| ⚡ | duty cycle | 40 % | ⚡ | efficiency | 70 % |

HECHT 2023 HOT AIR GUN



Adjustable temperature setting 60-600 °C



| | | | | | |
|---|-------------|-------------|---|---------------------|-----------------------|
| ⚡ | electric | 230 V/50 Hz | 🌡 | temperature setting | 60–350 °C / 60–600 °C |
| ⚡ | power input | 2000 W | 🌀 | air volume | 300 / 500 l/min |
| ⚖ | weight | 0,9 kg | | | |

HECHT 2022 HOT AIR GUN

Air volume setting 300/500 l / min



| | | | | | |
|---|-------------|-------------|---|---------------------|-----------------|
| ⚡ | electric | 230 V/50 Hz | 🌡 | temperature setting | 350 / 550 °C |
| ⚡ | power input | 2000 W | 🌀 | air volume | 300 / 500 l/min |
| ⚖ | weight | 0,7 kg | | | |

* Maximum working time without load with 2 Ah battery.

HEATERS

HECHT 3804

**ELECTRIC
AIR COOLER**

FUNCTION:
fan
cooling
humidification



| | | | | | |
|---|---|-------------|--------|------------------|-----------|
| ⚡ | electric | 230 V/50 Hz | litres | watertank volume | 4 l |
| ⚡ | power input | 75 W | 🌀 | airflow | 252 m³/h |
| 👤 | weight | 4,5 kg | ❄️ | class | Climate T |
| ⓘ | remote control, 3-speed ventilator, temperature display, 8 hours timer, 3 fan settings - swing, timer; 3 modes - natural, normal, sleep | | | | |

HECHT 3810

**BLADELESS
AIR COOLER**

FUNCTION:
fan
cooling
humidification



**Remote
control**

| | | | | | |
|---|---|-------------|--------|------------------|-----------|
| ⚡ | electric | 230 V/50 Hz | litres | watertank volume | 3,5 l |
| ⚡ | power input | 110 W | 🌀 | airflow | 428 m³/h |
| 👤 | weight | 5,7 kg | ❄️ | class | Climate T |
| ⓘ | remote control, 3-speed ventilator, temperature display, 8 hours timer, 3 fan settings - swing, timer; 3 modes - natural, normal, sleep | | | | |

HECHT 3809 AIR COOLER

FUNCTION:
fan
cooling
humidification



**Remote
control**



**Remote
control**

HECHT 3522 CONVECTION HEATER

LED display



| | | | | | |
|----|--|-------------|---|-----------------------|--------------------|
| ⚡ | electric | 230 V/50 Hz | 📏 | heating area | 20-25 m² |
| ⚡ | power input | 2000 W | 📏 | dimensions incl. base | 920 × 240 × 430 mm |
| 👤 | weight | 7,4 kg | 🔥 | thermal fuse | ✓ |
| IP | protection degree | IP24 | | | |
| ⓘ | fan, thermostat, stainless steel heating element with surface finish | | | | |

HECHT 3544

**ELECTRICAL LOCAL
HEATER**



HECHT 3545

**ELECTRICAL LOCAL
HEATER**



| | | | | | |
|----|--|---------------|----|--------------|--------------------|
| ⚡ | electric | 230 V / 50 Hz | 📏 | heating area | 20 m² |
| ⚡ | power input | 2000 W | 🌀 | airflow | 190 m³/h |
| 👤 | weight | 1,3 kg | ⚙️ | setting | 22 / 1000 / 2000 W |
| IP | protection degree | IP20 | 🔥 | thermal fuse | ✓ |
| ⓘ | electronic temperature control in the room | | | | |

| | | | | | |
|----|--|---------------|----|--------------|--------------------|
| ⚡ | electric | 230 V / 50 Hz | 📏 | heating area | 30 m² |
| ⚡ | power input | 3000 W | 🌀 | airflow | 238 m³/h |
| 👤 | weight | 1,8 kg | ⚙️ | setting | 30 / 2000 / 3000 W |
| IP | protection degree | IP20 | 🔥 | thermal fuse | ✓ |
| ⓘ | electronic temperature control in the room | | | | |

HEATERS



HECHT 3329
ELECTRIC HEATER
WITH THERMOSTAT

| | | | | | |
|----|--|---------------|----|--------------|-----------------------|
| ⚡ | electric | 230 V / 50 Hz | 🔥 | heating area | 60 m ³ |
| 🔌 | power input | 3000 W | 🌀 | airflow | 354 m ³ /h |
| 👤 | weight | 3,4 kg | ⚙️ | setting | 40 / 1500 / 3000 W |
| IP | protection degree | IPX4 | 🔥 | thermal fuse | ✓ |
| 📄 | fan, thermostat, stainless steel heating element with surface finish | | | | |



HECHT 3422
ELECTRIC HEATER
WITH THERMOSTAT

| | | | | | |
|----|--|---------------|----|--------------|-----------------------|
| ⚡ | electric | 230 V / 50 Hz | 🔥 | heating area | 60 m ³ |
| 🔌 | power input | 3000 W | 🌀 | airflow | 420 m ³ /h |
| 👤 | weight | 5 kg | ⚙️ | setting | 40 / 1500 / 3000 W |
| IP | protection degree | IP24 | 🔥 | thermal fuse | ✓ |
| 📄 | fan, thermostat, stainless steel heating element with surface finish | | | | |

Available from 8/25

WORKSHOP / TOOLS



HECHT 3610
CERAMIC HEATER

| | | | | | |
|----|--|-------------|----|--------------|----------------------|
| ⚡ | electric | 230 V/50 Hz | 🔥 | heating area | 15-20 m ² |
| 🔌 | power output | 2000 W | 🌀 | airflow | 80 m ³ /h |
| 👤 | weight | 4,5 kg | ⚙️ | setting | 1200 / 2000 W |
| IP | protection degree | IP24 | 🔥 | thermal fuse | ✓ |
| 📄 | thermostat, timer, remote control, ceramic heating element | | | | |



HECHT 3611
CERAMIC HEATER

| | | | | | |
|----|--|---------------|-------|-------------------------|---------------|
| ⚡ | electric | 230 V / 50 Hz | 🌡️ °C | max. output temperature | 130 °C |
| 🔌 | power output | 2200 W | ⚙️ | setting | 1200 / 2200 W |
| 👤 | weight | 5,3 kg | | | |
| IP | protection degree | IP24 | 🔥 | thermal fuse | ✓ |
| 📄 | thermostat, timer, remote control, ceramic heating element | | | | |

HECHT 003015A
HOSE WITH REGULATOR
1,5 M FOR HECHT 3015



Includes hose and regulator

HECHT 3015
GAS HOT AIR TURBINE
(Not intended for DE)

| | | | | | |
|----|-------------------|---------------|-------|-----------------|--------------------|
| ⚡ | electric | 230 V / 50 Hz | 🔥 | heating area | 100 m ³ |
| 🔌 | power input | 28 W | 🌡️ °C | heat output | 15 kW |
| 👤 | weight | 4,7 kg | | consumption | 1,07 kg/h |
| IP | protection degree | IP44 | 🌀 | fan, thermostat | |

HECHT 003016
HOSE WITH REGULATOR
1,5 M FOR HECHT 3016



Power regulation

Includes hose and regulator

HECHT 3016
GAS HOT AIR TURBINE
(Not intended for DE)

| | | | | | |
|----|-------------------|---------------|-------|-----------------|--------------------|
| ⚡ | electric | 230 V / 50 Hz | 🔥 | heating area | 280 m ³ |
| 🔌 | power input | 57 W | 🌡️ °C | heat output | 12-30 kW |
| 👤 | weight | 6,5 kg | | consumption | 1,07-2,13 kg/h |
| IP | protection degree | IP44 | 🌀 | fan, thermostat | |

Available from 8/25

HEATERS







HECHT 3020 DIESEL HOT AIR TURBINE









HECHT 3021 DIESEL HOT AIR TURBINE



Transport wheels

| | | | | | |
|--|-------------------|---------------|---|--------------|--------------------|
|  | electric | 230 V / 50 Hz |  | heating area | 166 m ³ |
|  | power input | 200 W |  | heat output | 20 kW / 70000 BTU |
|  | tank volume | 19 l |  | consumption | 2 l/h |
| IP | protection degree | IP20 | termostat, fan, automatic shutdown | | |

| | | | | | |
|---|-------------------|---------------|---|--------------|--------------------|
|  | electric | 230 V / 50 Hz |  | heating area | 166 m ³ |
|  | power input | 200 W |  | heat output | 20 kW / 70000 BTU |
|  | tank volume | 19 l |  | consumption | 2 l/h |
| IP | protection degree | IP20 | termostat, fan, automatic shutdown | | |

HECHT 3038 DIESEL HOT AIR TURBINE









Transport wheels

HECHT 3039 DIESEL HOT AIR TURBINE









Transport wheels

Available from 8/25

| | | | | | |
|--|-------------------|---------------|---|--------------|--------------------|
|  | electric | 230 V / 50 Hz |  | heating area | 295 m ³ |
|  | power input | 280 W |  | heat output | 37 kW / 125000 BTU |
|  | tank volume | 38 l |  | consumption | 3,6 l/h |
| IP | protection degree | IP20 | termostat, fan, automatic shutdown | | |

Available from 8/25

| | | | | | |
|---|-------------------|---------------|---|--------------|--------------------|
|  | electric | 230 V / 50 Hz |  | heating area | 415 m ³ |
|  | power input | 280 W |  | heat output | 51 kW / 175000 BTU |
|  | tank volume | 50 l |  | consumption | 5 l/h |
| IP | protection degree | IP20 | termostat, fan, automatic shutdown | | |

Indirect combustion
Flue gas discharge through the chimney







Heating with clean hot air

HECHT 3040 DIESEL HOT AIR TURBINE



Transport wheels

Available from 8/25

| | | | | | |
|--|-------------------|---------------|---|--------------|--------------------|
|  | electric | 230 V / 50 Hz |  | heating area | 150 m ³ |
|  | power input | 280 W |  | heat output | 18 kW / 62000 BTU |
|  | tank volume | 38 l |  | consumption | 1,8 l/h |
| IP | protection degree | IP20 | termostat, fan, automatic shutdown | | |

HECHT SPARKLIS

WOOD STOVES *
(not intended for A, CH, F)

- Air-flow adjustent
- Top flute position
- Storage compartment
- Made in Europe
- Fuel: wood, wooden briquettes
- Energy class A



firebox dimensions: 250x230x350 mm

| | | | | | |
|--|-----------------------|-----------------|--|----------|--------|
| | heat output | 5-7 kW | | flue | 120 mm |
| | combustion efficiency | 74 % | | weight | 31 kg |
| | dimensions | 330x368 x940 mm | | material | steel |

HECHT VERVIS

WOOD STOVES *
(not intended for A, CH, F)

- Air-flow adjustent
- Top / back flute position
- Cast iron door
- Heatproof glass
- Made in Europe
- Fuel: wood, wooden briquettes
- Energy class A



firebox dimensions: 250x280x350 mm

| | | | | | |
|--|-----------------------|-----------------|--|----------|------------------|
| | heat output | 6-7 kW | | flue | 120 mm |
| | combustion efficiency | 75 % | | weight | 48 kg |
| | dimensions | 400x460 x900 mm | | material | steel, cast iron |

HECHT FLEMIS

WOOD STOVES *
(not intended for A, CH, F)

- Air-flow adjustent
- Top flute position
- Heatproof glass
- Made in Europe
- Fuel: wood, wooden briquettes
- Energy class A



MODEL 2024

firebox dimensions: 340x325x350 mm

| | | | | | |
|--|-----------------------|-----------------|--|----------|--------|
| | heat output | 7-9 kW | | flue | 120 mm |
| | combustion efficiency | 76 % | | weight | 55 kg |
| | dimensions | 485x435 x945 mm | | material | steel |

HECHT FENIXE

WOOD STOVES *
(not intended for A, CH, F)

- Air-flow adjustent
- Top flute position
- Made in Europe
- Heatproof glass
- Ceramic siding
- Fuel: wood, wooden briquettes
- Energy class A



MODEL 2024

firebox dimensions: 335x320x350 mm

| | | | | | |
|--|-----------------------|-----------------|--|----------|----------------|
| | heat output | 9-10 kW | | flue | 120 mm |
| | combustion efficiency | 77 % | | weight | 82 kg |
| | overall dimensions | 490x460x1040 mm | | material | steel, ceramic |

HECHT ARDENIS

WOOD STOVES *
(not intended for A, CH, F)

- Air-flow adjustent
- Top flute position
- Made in Europe
- Cast iron door
- Heatproof glass
- Varnished siding
- Fireplace tiled with vermiculite
- Fuel: wood, wooden briquettes
- Energy class A



firebox dimensions: 320x350x360 mm

| | | | | | |
|--|-----------------------|-----------------|--|----------|------------------|
| | heat output | 7-8 kW | | flue | 120 mm |
| | combustion efficiency | 75 % | | weight | 64 kg |
| | dimensions | 480x460 x930 mm | | material | steel, cast iron |

ACCESSORIES for wood stoves with Ø120 / 130 / 150 mm flue

| | | |
|----------------------------|--------------------|---|
| | HECHT SAVER | HOT AIR EXCHANGER (MATERIAL STEEL, Ø 120 MM, DIMENSIONS 22x32x94-100 CM, THICKNESS 0,5 MM) |
| HECHT PIPE 1 | | FLUE PIPE 1 M / Ø 120 MM / 0,5 MM |
| HECHT PIPE 05 | | FLUE PIPE 0,5 M / Ø 120 MM / 0,5 MM |
| HECHT PIPE CURVE | | FLUE ELBOW 90° / Ø 120 MM / 0,5 MM |
| HECHT PIPE 113 | | FLUE PIPE 1 M / Ø 130 MM / 1,5 MM |
| HECHT PIPE 0513 | | FLUE PIPE WITH A FLAP 0,5 M / Ø 130 MM / 1,5 MM |
| HECHT PIPE CURVE 13 | | FLUE ELBOW 90° / Ø 130 MM / 1,5 MM |
| HECHT PIPE 115 | | FLUE PIPE 1 M / Ø 150 MM / 1,5 MM |
| HECHT PIPE 0515 | | FLUE PIPE WITH A FLAP 0,5 M / Ø 150 MM / 1,5 MM |
| HECHT PIPE CURVE 15 | | FLUE ELBOW 90° / Ø 150 MM / 1,5 MM |

* The heating capacity of fireplace stoves ranges from 11-15 m³/kW.

However, this figure is indicative, in fact it depends greatly on the thermal insulation properties of the buildings and the climate. More info at www.hecht.cz in the Stoves section.

HECHT PRECIS

**WOOD STOVES *
WITH HOT WATER EXCHANGER
(not intended for A, CH, F)**

Max. operating pressure 2.5 bar

Exchanger volume 16 l

Heat resistant glass

Air flow adjustment

Top flute position

Cast iron grate

Fuel: wood, wooden briquettes

Energy class A



firebox dimensions: 350×320×390 mm

| | | | | | |
|--|-------------------------------------|--------------------|--|----------|--------|
| | rated power / air flow / water flow | 13,1/ 4,4 / 8,7 kW | | flue | 120 mm |
| | exchanger volume | 16 l | | weight | 71 kg |
| | dimensions | 465×465×900 mm | | material | steel |

HECHT MAGNIS

**WOOD STOVES *
WITH HOT WATER EXCHANGER
(not intended for A, CH, F)**

Max. operating pressure 2.5 bar

Top flute position

Exchanger volume 22 l

Heatproof glass

Air flow adjustment

Ceramic siding

Cast iron grate

Fuel: wood, wooden briquettes

Energy class A



firebox dimensions: 310×300×530 mm

| | | | | | |
|--|--------------------------------|------------------|--|----------|-----------------|
| | max. heating output / in water | 20–22 / 15–17 kW | | flue | 120 mm |
| | combustion efficiency | 77 % | | weight | 90 kg |
| | overall dimensions | 485×455×1070 mm | | material | steel, ceramics |

HECHT SOLIS BEIGE / GREY

**WOOD STOVES *
(not intended for A, CH, F)**

Air-flow adjustent

Heatproof glass

Fireplace tiled with vermiculite

Fuel: wood, wooden briquettes

Tertiary combustion

Energy class A+



firebox dimensions: 400×370×400 mm

| | | | | | |
|--|--|----------------|--|----------|--------|
| | heat output | 9 kW | | flue | 150 mm |
| | combustion efficiency | 81 % | | weight | 83 kg |
| | overall dimensions | 570×470×930 mm | | material | steel |
| | top flute position, storage compartment, fuel: wood, wooden briquettes | | | | |

HECHT HELIS BEIGY / GREY

**WOOD STOVES *
(not intended for A, CH, F)
With stone cladding:
polished limestone**

Air-flow adjustent

Heatproof glass

Fireplace tiled with vermiculite

Fuel: wood, wooden briquettes

Tertiary combustion

Energy class A+



firebox dimensions: 400×370×400 mm

| | | | | | |
|--|--|----------------|--|----------|--------------|
| | heat output | 9 kW | | flue | 150 mm |
| | combustion efficiency | 81 % | | weight | 83 kg |
| | overall dimensions | 570×470×930 mm | | material | steel, stone |
| | top flute position, storage compartment, fuel: wood, wooden briquettes | | | | |

HECHT VULCANUS GREY

**WOOD STOVES WITH OVEN *
(not intended for DE, A, CH, F)**

Flue Ø 130 cm

Adjustable oven power

Top hob 5 mm

Heatproof glass

Thermometer

Fuel: wood, wooden briquettes

Energy class A



| | | | | | |
|--|-----------------------|----------------|--|-----------------|----------------|
| | heat output | 6 kW | | weight | 65 kg |
| | combustion efficiency | 74 % | | material | steel |
| | overall dimensions | 850×520×890 mm | | oven dimensions | 440×420×250 mm |

HECHT VULCANUS BEIGE

**WOOD STOVES WITH OVEN *
(not intended for DE, A, CH, F)**

Flue Ø 130 cm

Adjustable oven power

Top hob 5 mm

Heatproof glass

Thermometer

Fuel: wood, wooden briquettes

Energy class A



| | | | | | |
|--|-----------------------|----------------|--|-----------------|----------------|
| | heat output | 6 kW | | weight | 65 kg |
| | combustion efficiency | 74 % | | material | steel, ceramic |
| | overall dimensions | 850×520×890 mm | | oven dimensions | 440×420×250 mm |

CHARCOAL GARDEN GRILLS

HECHT BBQ SET

3in1



Suitable for sheltered garden areas

Available from 2/25

HECHT MERIDA CHARCOAL GARDEN GRILL



| | | | | | |
|--|--|----------------------------|--|-----------------|---------|
| | material | heat resistant sheet steel | | steel thickness | 0,8 mm |
| | dimensions | 54 x 57 x 92 cm | | cooking area | 53,5 cm |
| | weight | 11,5 kg | | | |
| | heat-resistant black color, stainless steel grill, ashtray, transport wheels | | | | |

HECHT VESUV CHARCOAL GARDEN GRILL

BBQ & FIRE PIT



3 IN 1

| | | | | | |
|--|---|----------------------------|--|-----------------|------------|
| | material | heat resistant sheet steel | | steel thickness | 1,2 mm |
| | dimensions | 88 x 73 x 92 cm | | cooking area | 46 x 46 cm |
| | weight | 21 kg | | | |
| | heat-resistant black color, stainless steel grill, two wooden shelves | | | | |

HECHT CALIFORNIA CHARCOAL GARDEN GRILL



NEW

Available from 2/25

| | | | | | |
|--|---|----------------------------|--|-----------------|--------------|
| | material | heat resistant sheet steel | | steel thickness | 0,8 mm |
| | dimensions | 77,5 x 54,3 x 32,5 cm | | cooking area | 61,5 x 46 cm |
| | weight | 27,5 kg | | | |
| | heat-resistant black color, stainless steel grill, two wooden shelves | | | | |

HECHT BARREL CHARCOAL GARDEN GRILL



Available from 2/25

| | | | | | |
|--|---|----------------------------|--|-----------------|------------|
| | material | heat resistant sheet steel | | steel thickness | 1 mm |
| | dimensions | 108 x 72 x 102 cm | | cooking area | 73 x 37 cm |
| | weight | 20 kg | | | |
| | 2 cooking areas, stacking area, ashtray, transport wheels | | | | |

HECHT SENTINEL MINOR CHARCOAL GARDEN GRILL

Suitable for sheltered garden areas



Available from 2/25

| | | | | | |
|--|---|----------------------------|--|---------------------------|-------------------------|
| | material | heat resistant sheet steel | | steel thickness | 1 mm |
| | dimensions | 112 x 63 x 116,5 cm | | cooking area main / minor | 30 x 52 cm / 30 x 22 cm |
| | weight | 21 kg | | | |
| | 2 heating chambers, 2 cooking areas, stacking area, thermometer, transport wheels | | | | |

HECHT 000666 GRILOVACÍ PLÁT



HECHT SENTINEL CHARCOAL GARDEN GRILL

Suitable for sheltered garden areas



Available from 2/25

| | | | | | |
|--|---|----------------------------|--|---------------------------|--------------------------------------|
| | material | heat resistant sheet steel | | steel thickness | 1 mm |
| | dimensions | 115 x 65 x 133 cm | | cooking area main / minor | 60 x 40 cm / 35 x 30 cm / 59 x 19 cm |
| | weight | 35 kg | | | |
| | 2 heating chambers, 2 cooking areas, stacking area, thermometer, transport wheels | | | | |

CHARCOAL AND GAS GARDEN GRILLS

HECHT SENTINEL MAX CHARCOAL GARDEN GRILL

Suitable for sheltered garden areas

Suitable for sheltered garden areas

Not intended for D and PI

Integrated thermometer

Transport wheels

Available from 2/25

HECHT FIRE 2 GAS GRILL

NEW

HECHT COVER 2
(for HECHT FIRE 2)

grill dimensions 93 × 48 × 98 cm

weight 12,5 kg

2 main burners, cast iron grate, total burner output 5,6 kW

cooking area 45 × 41 cm



Available from 2/25

| | | | | | |
|--|---|----------------------------|--|---------------------------|--------------------------|
| | material | heat resistant sheet steel | | steel thickness | 1,5 mm |
| | dimensions | 175 × 76 × 154 cm | | cooking area main / minor | 100 × 45 cm / 43 × 38 cm |
| | weight | 76 kg | | | |
| | 2 heating chambers, 3 cooking areas, stacking area, thermometer, transport wheels | | | | |



HECHT CONTACT 3 GAS GRILL

NEW

Suitable for sheltered garden areas

Not intended for D and PI

Suitable for sheltered garden areas

Not intended for D and PI

Cast iron grate and grill plate

Integrated thermometer

Transport wheels

grill dimensions 101 × 48 × 986 cm

weight 17,5 kg

3 main burners, cast iron grate, total burner output 8,4 kW

cooking area 61 × 41 cm

HECHT COVER 3C
(for HECHT CONTACT 3)

HECHT FIREWOOD 3 GAS GRILL

NEW

Suitable for sheltered garden areas

NEW

Cast iron grate



Not intended for D and PI

Integrated thermometer

Transport wheels

Available from 2/25
HECHT COVER 4
(for HECHT ADELLE 4)

grill dimensions 132 × 53 × 114 cm

weight 36 kg

4 main burners, 1 side burner, total burner output 13 kW, door

cooking area 60 × 40 cm

HECHT CAMPANA 5 GAS GRILL

GAS GRILL

Suitable for sheltered garden areas

NEW

HECHT 003101R

REGULATOR FOR GAS GRILLS

28–30 mbar, Ø 8 mm, length 1,5 m

Intended for CZ, SK, HU or on request.

Integrated thermometer

Available from 2/25

grill dimensions 139,5 × 54,5 × 114 cm

weight 46 kg

4 main burners, 1 side burner, total burner output 16,5 kW, door

cooking area 71 × 41,5 cm

HECHT COVER 5C
(for HECHT CAMPANA 5)



Cast iron grate

Transport wheels

GARDEN FURNITURE

HECHT FOLDIS WHITE SET

GARDEN FURNITURE SET (1x table, 2x bench)

HECHT FOLDIS WHITE BENCH GARDEN BENCH

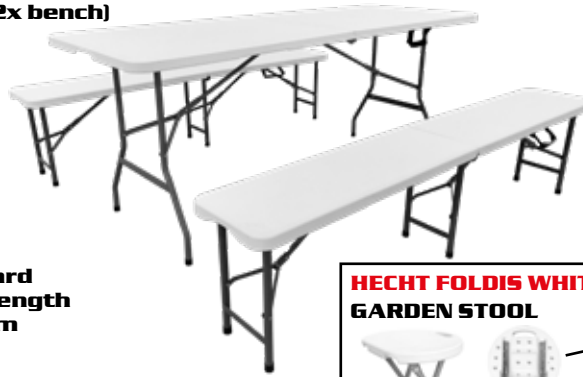
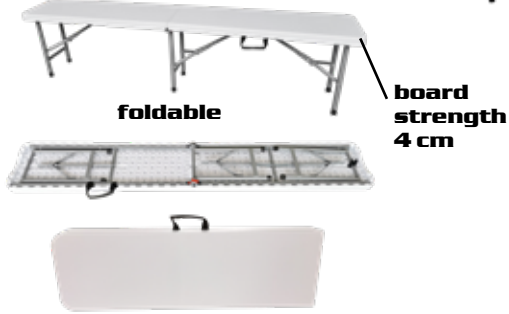

HECHT FOLDIS WHITE TABLE GARDEN TABLE



HECHT FOLDIS WHITE STOOL GARDEN STOOL



| | | | | | |
|------------------|------------------------|-----------------|--------|--|---|
| table dimensions | L 180 x W 74 x H 74 cm | max. load bench | 400 kg | Suitable for exterior and interior | Suitable for camping and other outdoor activities |
| bench dimensions | L 180 x W 30 x H 43 cm | max. load stool | 120 kg | Set of table and two benches made of steel-aluminum profiles with komaxit finish. The surface of the table and chairs is made of highly durable plastic. | |
| stool dimensions | L 32 x W 29 x H 46 cm | table, bench | 1x, 2x | Stool available for additional purchase. | |

HECHT FOLDIS RATTAN SET

GARDEN FURNITURE SET (1x table, 2x bench)

HECHT FOLDIS RATTAN BENCH GARDEN BENCH

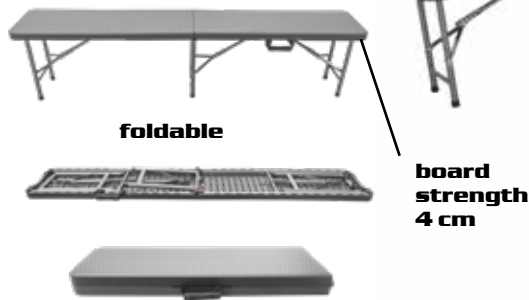

HECHT FOLDIS RATTAN TABLE GARDEN TABLE



| | | | | | |
|------------------|------------------------|-----------------|--------|--|---|
| table dimensions | L 180 x W 74 x H 74 cm | bench max. load | 400 kg | Suitable for exterior and interior | Suitable for camping and other outdoor activities |
| bench dimensions | L 180 x W 30 x H 43 cm | table, bench | 1x, 2x | Set of table and two benches made of steel-aluminum profiles with komaxit finish. The surface of the table and chairs is made of highly durable plastic. | |

HECHT FOLDIS SET 6

GARDEN FURNITURE SET

HECHT FOLDIS CHAIR GARDEN CHAIR



HECHT FOLDIS TABLE GARDEN TABLE

Available from 2/25

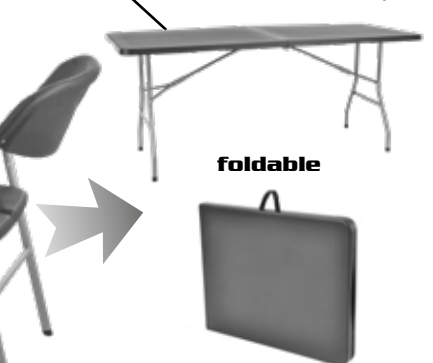

| | | | | | |
|------------------|------------------------|-----------------|--------|---|---|
| table dimensions | L 180 x W 74 x H 74 cm | chair max. load | 120 kg | Suitable for exterior and interior | Suitable for camping and other outdoor activities |
| chair dimensions | L 56 x W 46 x H 84 cm | table, chair | 1x, 6x | Folding set of six chairs and one table made of steel-aluminum profiles with komaxit finish. The surface of the table and chairs is made of highly durable plastic. | |

EKONOMY SET 4 GARDEN FURNITURE SET

Tempered glass

EKONOMY SET 6 GARDEN FURNITURE SET

EKONOMY CHAIR GARDEN CHAIR



EKONOMY TABLE GARDEN GLASS TABLE



| | | | | | |
|------------------|------------------------|-----------------|----------|---|---|
| table dimensions | L 141 × W 91 × H 73 cm | chair max. load | 120 kg | Table top made of tempered glass | Not suitable for high humidity conditions |
| chair dimensions | L 55 × W 76 × H 96 cm | table, chair | 1×, 4/6× | A combined set of chairs (stackable) and a table made of steel and aluminum profiles. | |



SOFIA SET 4 GARDEN FURNITURE SET

Tempered glass

SOFIA SET 6 GARDEN FURNITURE SET

SOFIA CHAIR GARDEN CHAIR

www.hecht.cz



Aluminium

SOFIA TABLE GARDEN GLASS TABLE

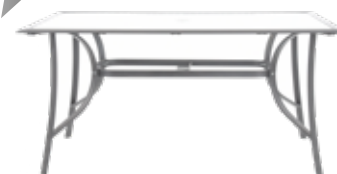

| | | | | | |
|------------------|------------------------|-----------------|----------|--|--|
| table dimensions | L 150 × W 90 × H 73 cm | chair max. load | 120 kg | Table top made of tempered glass | Suitable for use also in wet conditions. |
| chair dimensions | L 55 × W 75 × H 95 cm | table, chair | 1×, 4/6× | Combined set of chairs (stackable) and a table made of aluminum profiles. Suitable for use outside and inside. | |



HONEY SET 4 GARDEN FURNITURE SET

Tempered black glass

HONEY SET 6 GARDEN FURNITURE SET

HONEY CHAIR GARDEN CHAIR



Aluminium

HONEY TABLE GARDEN GLASS TABLE



| | | | | | |
|------------------|------------------------|-----------------|----------|---|--|
| table dimensions | L 150 × W 90 × H 72 cm | chair max. load | 120 kg | Table top made of tempered glass | Suitable for high humidity conditions. |
| chair dimensions | L 58 × W 74 × H 97 cm | table, chair | 1×, 4/6× | A combined set of chairs (stackable) and a table made of aluminum profiles. | |



SHADOW SET GARDEN FURNITURE SET

Available from 2/25

SHADOW CHAIR
GARDEN ADJUSTABLE CHAIR
Available from 2/25



Tempered black glass

Aluminium

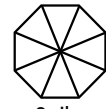

8 ribs



Foldable

SHADOW TABLE
GARDEN GLASS TABLE



| | | | | | |
|------------------|------------------------|-----------------------|--------------------------------------|--|---|
| table dimensions | L 150 × W 90 × H 72 cm | parasol | Ø 270 cm, V 220 cm, 8 ribs, foldable | Table with hardened black glass. Max. load of chair 120 kg. | Suitable for exteriors and interiors, also for use in humid environments. |
| chair dimensions | L 56 × W 65 × H 107 cm | table, chair, parasol | 1 ×, 6 ×, 1 × | Combined set of six chairs (adjustable - 7 positions), one table made of aluminum profiles with Komaxit surface treatment and one parasol. | |

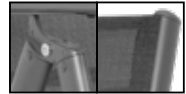

HONEY SET MAXI GARDEN FURNITURE SET

HONEY MAXI CHAIR
GARDEN CHAIR



Extended backrest

Aluminium
Tempered black glass

HONEY MAXI TABLE
GARDEN GLASS TABLE



| | | | | | |
|------------------|------------------------|-----------------|----------|---|--|
| table dimensions | L 168 × W 97 × H 72 cm | chair max. load | 120 kg | Table top made of tempered glass | Suitable for high humidity conditions. |
| chair dimensions | L 57 × W 86 × H 111 cm | table, chair | 1 ×, 6 × | A combined set of chairs (stackable) and a table made of aluminum profiles. | |



HECHT NAVASSA SET 4

GARDEN FURNITURE SET

HECHT NAVASSA SET 6

GARDEN FURNITURE SET

Expanded metal

HECHT NAVASSA CHAIR

GARDEN CHAIR

Available from 2/25



Quality steel construction

HECHT NAVASSA TABLE

GARDEN TABLE

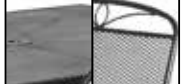

| | | | | | | |
|------------------|-------------------------|-----------------|----------|---|---|---|
| table dimensions | L 153 × W 96 × H 73 cm | chair max. load | 120 kg | Suitable for outdoor and indoor use. | Not suitable for use in wet conditions. |  |
| chair dimensions | L 56 × W 72 × H 99,5 cm | table, chair | 1×, 4/6× | A combined set of chairs (stackable) and a table made of expanded metal with komaxit surface. | | |

HECHT LIMA SET 4

GARDEN FURNITURE SET

HECHT LIMA SET 6

GARDEN FURNITURE SET

HECHT LIMA CHAIR

GARDEN CHAIR

www.hecht.cz



Polywood



Aluminium

HECHT LIMA TABLE

GARDEN TABLE



| | | | | | |
|------------------|------------------------|-----------------------|-----------|---|--|
| table dimensions | L 150 × W 90 × H 75 cm | chair/table max. load | 120/80 kg | Suitable for gardens and interiors | Also suitable for use in humid environments. |
| chair dimensions | L 55 × W 56 × H 84 cm | table, chair | 1×, 4/6× | A luxurious set of chairs and a table made of aluminum with powdercoating finish. Table top, seat and backrest from polywood. | |

HECHT MONTANA

GARDEN FURNITURE SET

Convertible table



HECHT MONTANA CHAIR

GARDEN CHAIR



Adjustable chairs



Acacia wood

HECHT MONTANA TABLE

GARDEN FOLDABLE TABLE



| | | | | | |
|------------------|------------------------------|-----------------|--------|--|--|
| table dimensions | L 140/180 × W 90 × H 77,5 cm | chair max. load | 120 kg | Suitable for outdoor and indoor use. | Also suitable for use in wet conditions. |
| chair dimensions | L 69 × W 59 × H 111,5 cm | table, chair | 1×, 6× | A luxury combined set of six adjustable chairs from waterproof fabric and one convertible table made all of aluminium profiles with powdercoating finishing and acacia wood. | |

HECHT BASIC SET 4

GARDEN FURNITURE SET

HECHT BASIC CHAIR
GARDEN CHAIR



Acacia wood

HECHT BASIC SET 6

GARDEN FURNITURE SET

HECHT BASIC TABLE
GARDEN TABLE



| | | | | |
|------------------|------------------------|-----------------|----------|---|
| table dimensions | L 120 × W 75 × H 72 cm | chair max. load | 120 kg | Suitable for use inside garden rooms and terraces. With appropriate impregnation, it can be used outdoors. |
| chair dimensions | L 53 × W 57 × H 86 cm | table, chair | 1×, 4/6× | A luxury garden furniture set consisting of chairs and a table. Made of hard and resistant acacia tree. Natural wood. There may be color differences with the illustrations, they are not a reason for complaint. |

HECHT CAMBERET SET

GARDEN FURNITURE SET

HECHT CAMBERET CHAIR / ROYAL CHAIR
GARDEN CHAIR



Foldable table

Adjustable chairs



HECHT CAMBERET TABLE
GARDEN TABLE



Acacia wood

| | | | | |
|------------------|-----------------------------|-----------------|--------|--|
| table dimensions | L 150/200 × W 100 × H 74 cm | chair max. load | 160 kg | Made of hard and resistant acacia tree. Suitable for use inside garden rooms and terraces. With appropriate impregnation, it can be used outdoors. |
| chair dimensions | L 58 × W 68 × H 110 cm | table, chair | 1×, 6× | A luxurious set of folding chairs and a table. Natural wood. There may be color differences in relation to the illustrations, they are not a reason for complaint. |

HECHT ROYAL SET

GARDEN FURNITURE SET

HECHT CAMBERET CHAIR / ROYAL CHAIR
GARDEN CHAIR



8 adjustable chairs



Massive construction

Table desk thickness cca 4 cm

Acacia wood



HECHT ROYAL TABLE
GARDEN TABLE



| | | | | |
|------------------|-----------------------------|-----------------|--------|--|
| table dimensions | L 180/280 × W 115 × H 76 cm | chair max. load | 160 kg | Made of hard and resistant acacia hardwood. Suitable for use inside garden rooms and terraces. With appropriate impregnation, it can be used outdoors. |
| chair dimensions | L 58 × W 68 × H 110 cm | table, chair | 1×, 8× | A luxurious set of folding chairs and table. Natural wood. There may be color differences in relation to the illustrations, they are not a reason for complaint. |

* The heating capacity of fireplace stoves ranges from 11-15 m³/kW.

However, this figure is indicative, in fact it depends greatly on the thermal insulation properties of the buildings and the climate. More info at www.hecht.cz in the Stoves section.

HECHT SIERRA GARDEN FURNITURE SET

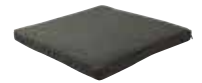

Cushions included

**Color fastness
Easy maintenance**

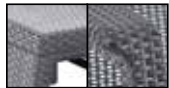

| | | | |
|---|-----------------------|--|--------|
| table dimensions | L 77 × W 57 × H 42 cm | chair max. load | 160 kg |
| chair dimensions | L 75 × W 70 × H 79 cm | table, chair | 1×, 2× |
| Suitable for gardens and interiors. | | Also suitable for use in humid environments. | |
| A luxurious set of two chairs and a table made of artificial rattan with a seat. Made of very durable polypropylene. Resistant to adverse weather conditions and UV radiation. High durability. | | | |

HECHT SIERRA MAXI GARDEN FURNITURE SET



Cushions included

**Color fastness
Easy maintenance**

www.hecht.cz

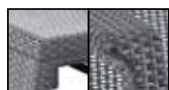

| | | | |
|---|------------------------|--|------------|
| table dimensions | L 77 × W 57 × H 42 cm | chair max. load | 160 kg |
| chair dimensions | L 75 × W 70 × H 79 cm | table, chair, sofa | 1×, 2×, 1× |
| sofa dimensions | L 128 × W 70 × H 79 cm | | |
| Suitable for gardens and interiors | | Also suitable for use in humid environments. | |
| A luxurious set of two chairs, sofa and table made of artificial rattan with a seat. Made of very durable polypropylene. Resistant to adverse weather conditions and UV radiation. High durability. | | | |

HECHT GABBIANI GARDEN FURNITURE SET

HECHT GABBIANI CHAIR GARDEN CHAIR

HECHT GABBIANI TABLE GARDEN TABLE



NEW



**6 cm seat and
18 cm soft back
washable
cushions included**



| | | | |
|---|------------------|--|--------|
| table dimensions | 160 x 90 x 75 cm | chair max. load | 150 kg |
| chair dimensions | 64 x 70 x 85 cm | table, chair | 1x, 6x |
| Suitable for gardens and interiors | | Also suitable for use in humid environments. | |
| A luxurious set of six chairs and table made of artificial rattan with a seat. Made of very durable polypropylene. Resistant to adverse weather conditions and UV radiation. High durability. | | | |

HECHT RELAXING CHAIR

GARDEN CHAIR

High stability

Adjustable

www.hecht.cz

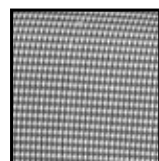

Available from 4/25

| | | | |
|---|-----------------------------------|---|--------|
| dimensions | L 157,5/81,5 × W 64 × H 90/112 cm | maximum load | 120 kg |
| Luxury adjustable armchair made of steel tubes. | | Not suitable for use in humid environments. | |
| Suitable for indoor garden areas and interiors. | | | |

HECHT PALAWAN

GARDEN LOUNGER

High rigidity

Easy maintenance

Adjustable

www.hecht.cz



MADE IN ITALY

| | | | |
|------------------------------------|-------------------------|--|--------|
| dimensions | L 192 × W 71 × H 100 cm | maximum load | 120 kg |
| weight | 12 kg | Luxurious adjustable lounger made of strong plastic. | |
| Suitable for indoors and outdoors. | | Can be used also in humid conditions. | |

HECHT CLAUDIA LOUNGER

GARDEN LOUNGER

NEW



| | | | |
|---|---------------|---|--------|
| dimensions | 63×195×105 cm | maximum load | 120 kg |
| Suitable for indoors and outdoors. | | Not suitable for use in humid environments. | |
| Luxurious adjustable lounger made of steel and aluminum profiles. | | | |

HECHT SOFIA LOUNGER

GARDEN LOUNGER

High stability

Adjustable



NEW



model 2024

| | | | |
|---|------------------------|----------------------------------|--------|
| dimensions | L 190 × W 65 × H 45 cm | maximum load | 120 kg |
| Suitable for indoors and outdoors. | | Can be used in humid conditions. | |
| Luxurious adjustable lounger made of aluminum profiles. | | | |

HECHT HONEY LOUNGER

GARDEN LOUNGER

NEW



Available from 2/25

| | | | |
|---|------------------------|----------------------------------|--------|
| dimensions | L 190 × W 65 × H 45 cm | maximum load | 120 kg |
| Suitable for indoors and outdoors. | | Can be used in humid conditions. | |
| Luxurious adjustable lounger made of aluminum profiles. | | | |

HECHT MONTANA LOUNGER

GARDEN LOUNGER

NEW



Acacia wood

Available from 2/25

| | | | |
|--|--|--------------|--------|
| dimensions | L 132 × W 66 × H 95 cm | maximum load | 120 kg |
| Suitable for outdoor and indoor use. | Also suitable for use in wet conditions. | | |
| Luxurious sun lounger made of aluminium profiles with powdercoating finishing and acacia wood. | | | |

HECHT RESORT I

GARDEN LOUNGER

Wheels for easier transport
Chair with shelf for magazines
Adjustable



Meranti wood



| | | | |
|--|--|--------------|--------|
| dimensions | L 193,5 × W 71 × H 30 cm | maximum load | 100 kg |
| Suitable for use inside garden rooms and terraces. | With appropriate impregnation it can be used outdoors. | | |
| Luxurious sun lounger made of hard exotic Meranti tree with an additional shelf. Natural wood. There may be color differences with the illustrations, they are not a reason for complaint. | | | |

HECHT RESORT A

GARDEN LOUNGER

Wheels for easier transport
Chair with shelf for magazines
Adjustable



Acacia wood



| | | | |
|---|--|--------------|--------|
| dimensions | L 200 × W 60 × H 30 cm | maximum load | 200 kg |
| Suitable for use inside garden rooms and terraces. | With appropriate impregnation it can be used outdoors. | | |
| Luxurious sun lounger made of hard exotic Acacia tree with an additional shelf. Natural wood. There may be color differences with the illustrations, they are not a reason for complaint. | | | |

HECHT ERA

GARDEN LOUNGER

Wheels for easier transport
Chair with shelf for magazines
Adjustable



Meranti wood



| | | | |
|--|--|--------------|--------|
| dimensions | L 195 × W 72 × H 30 cm | maximum load | 250 kg |
| Suitable for use inside garden rooms and terraces. | With appropriate impregnation it can be used outdoors. | | |
| Luxurious sun lounger made of hard exotic Meranti tree with an additional shelf. Natural wood. There may be color differences with the illustrations, they are not a reason for complaint. | | | |

HECHT BORNEO

GARDEN LOUNGER

High stability
Adjustable



Cushion included



| | | | |
|--|---------------------------------------|---|--------|
| dimensions | L 200 × W 73 × H 36 cm | maximum load | 180 kg |
| weight | 14 kg | Very elegant garden chair with adjustable back. | |
| Suitable for indoors and outdoors. | Can be used also in humid conditions. | | |
| Aluminium tube in powder coating finishing and rattan imitation. Resistant to adverse weather conditions and UV radiation. Very easy maintenance and cleaning. | | | |

HECHT CLASSIC

GARDEN BENCH



Acacia wood

High stability



| | | | |
|--|--|-----------------|--------|
| dimensions | L 158 × W 61 × H 89 cm | chair max. load | 300 kg |
| Suitable for use inside garden rooms and terraces. | With appropriate impregnation it can be used outdoors. | | |
| Luxurious garden bench made of hard exotic Acacia tree Natural wood. There may be color differences with the illustrations, they are not a reason for complaint. | | | |

HECHT BOX L GARDEN STORAGE BOX



270 L



dimensions 109 × 51,5 × 55 cm capacity 270 l

intended for indoor and outdoor use, molded handles, made of PP and steel



HECHT BOX XL GARDEN STORAGE BOX



680 L



dimensions 146,5 × 71 × 75 cm capacity 680 l

intended for indoor and outdoor use, molded handles, vacuum PP panels



HECHT BERLIN BENCH SWING

Stable construction



Available from 2/25

dimensions Š 196 × H 123 × V 179 cm maximum load 250 kg

material steel pipes with komaxit surface treatment

suitable for garden sheltered areas not suitable for humid environment

Durable three-seat garden swing made of steel pipes with a roof covered with fabric. A bench suspended on springs.

HECHT MARIOLU BENCH SWING

**2 positions:
Bench or bed**

Mattress included

Quick-drying polyester



Mattress thickness 8 cm



Available from 2/25

bed dimensions (expanded) L 194 × W 120 × H 173 cm max. load 240 kg

material steel frame with powder coating, 180g waterproof polyester cover, PVC coating seat, 160g waterproof polyester cushion

Suitable for use inside garden rooms and terraces. Not suitable for use in a humid environment.

Durable three-seat garden swing made of steel pipes with a roof covered with fabric. The backrest can be used in a horizontal or vertical position. A bench suspended on springs.

BERLIN HONEY BENCH SWING

Stable construction



Luxury storage side pockets included



dimensions Š 196 × H 123 × V 179 cm maximum load 250 kg

material steel pipes with komaxit surface treatment

suitable for garden sheltered areas not suitable for humid environment

Durable three-seat garden swing made of steel pipes with a roof covered with fabric. A bench suspended on springs.

HECHT BAHARU LUX BENCH SWING

**2 positions:
Bench or bed**

Mattress included

Quick-drying polyester



Available from 2/25



dimensions L 235 × W 120 × H 178 cm max. load 300 kg

material made of hard tropical Meranti hardwood

Suitable for use inside garden rooms and terraces. With appropriate impregnation it can be used outdoors.

Luxurious four-poster swing. The backrest can be used in a horizontal or vertical position. Natural wood. There may be color differences with the illustrations, they are not a reason for complaint.

ROCKING CHAIRS

HECHT DREAM

GARDEN ROCKING CHAIR

dimensions 200 x 140 x 210 cm

maximum load 120 kg

Available from 4/25

Perfect stability
Quick-drying polyester

A rocking chair with a roof. Made of steel pipes. Not suitable for use in high humidity conditions.



HECHT DREAM HONEY

GARDEN ROCKING CHAIR

dimensions 200 x 140 x 210 cm

maximum load 120 kg

Perfect stability
Quick-drying polyester

A rocking chair with a roof. Made of steel pipes. Not suitable for use in high humidity conditions.



www.hecht.cz

HECHT VICKY GREY

GARDEN FOLDING ROCKING CHAIR

dimensions 118 x 64 x 195 cm

maximum load 120 kg

NEW

18 cm seat cushion,
180 g polyester
with UV protection
included

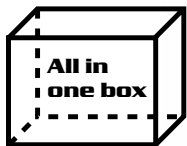

Made of with powder coated steel tubes Ø 42 mm and artificial ratan. Not suitable for use in high humidity conditions.

Available from 2/25



HECHT VICKY BLACK

GARDEN FOLDING ROCKING CHAIR

dimensions 118 x 64 x 195 cm

maximum load 120 kg

NEW

18 cm seat cushion,
180 g polyester
with UV protection
included



Made of with powder coated steel tubes Ø 42 mm and artificial ratan. Not suitable for use in high humidity conditions.

Available from 2/25



PARASOLS

HECHT SHADOW

GARDEN PARASOL

Available from 2/25

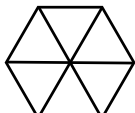

6 ribs



Foldable



Protection from UV radiation

Practical roof ventilation

Easy to control



| | | | |
|--|----------------|--------|--------------------------------|
| ø umbrella | 2,7 m | height | 2,2 m |
| crossbars | 8 pcs 12x18 mm | cover | polyester 180 g/m ² |
| sunshade with the option of tilting, polyester cover | | | |

SANDY G / C

GARDEN PARASOL

Available from 2/25



6 ribs

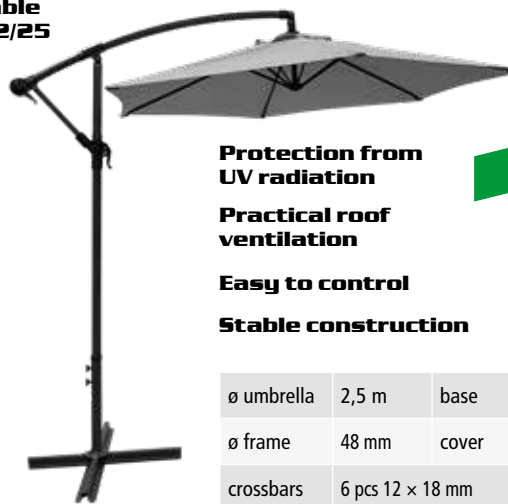

Protection from UV radiation

Practical roof ventilation

Easy to control

Stable construction

NEW



| | | | |
|------------|------------------|-------|--------------------------------|
| ø umbrella | 2,5 m | base | 100x100 cm |
| ø frame | 48 mm | cover | polyester 180 g/m ² |
| crossbars | 6 pcs 12 x 18 mm | | |

aluminum umbrella with a cross-shaped base, easy to open and close with the handle, polyester cover, practical roof ventilation

SUNNY

GARDEN PARASOL

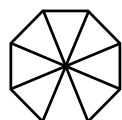

8 ribs



Available from 2/25

| | | | |
|------------|------------------|-------|--------------------------------|
| ø umbrella | 3 m | base | 100x100 cm |
| ø frame | 48 mm | cover | polyester 180 g/m ² |
| crossbars | 8 pcs 12 x 18 mm | | |

aluminum umbrella with a cross-shaped base, easy to open and close with the handle, polyester cover, practical roof ventilation



Protection from UV radiation

Practical roof ventilation

Easy to control

Stable construction

GARDEN FURNITURE

HECHT ROMA BASE

4 PCS OF WATER/SAND FILLABLE LOAD PLATES

(each 50x50x6 cm)
max weight: 4x 26 kg



Compatible with HECHT SANDY C/G., SUNNY, ROMA

HECHT ROMA

GARDEN PARASOL

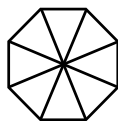

8 ribs

| | | | |
|------------|----------------|-------|--------------------------------|
| ø umbrella | 3,5 m | base | 100x100 cm |
| ø frame | 53x80 mm | cover | polyester 200 g/m ² |
| crossbars | 8 pcs 25x40 mm | | |

aluminum umbrella with a cross-shaped base, easy to open and close with the handle, polyester cover, practical roof ventilation

HECHT ROMA SET

GARDEN PARASOL WITH BASE
HECHT ROMA +
HECHT ROMA BASE



Vertical tilting
360° Rotating system

Protection from UV radiation

Practical roof ventilation

Stable construction

Polyester 200 g/m²

GARDEN PERGOLAS AND SHEDS

HECHT GAZEBO 34 GAZEBO



Robust construction

**Protection from
UV radiation**

**Available
from 2/25**

| | | | |
|-----------------|--------------------|-----------|------------------------------------|
| size | 400 × 300 × 270 cm | top cover | 180 g polyester with PA coating |
| entrance height | 200 cm | side wall | 160 g polyester, with 40 g netting |
| frame | aluminium/steel | | |

HECHT PERGOLA 4×3 PERGOLA



**FOLDING
ROOF**

**Protection from
UV radiation**

ALU frame

| | | | |
|-----------------|--------------------|--------------------|--------------------------------|
| size | 392 × 292 × 228 cm | upper sail | 160 g/m ² polyester |
| entrance height | 207 cm | supporting legs | 4 pcs (10 × 10 cm) |
| frame | 1,1 mm aluminium | anchoring supports | 20 × 20 cm |

**ANCHOR KIT
HECHT 000808**
for 4×6 PLUS, 6×8 PLUS,
8×8 PLUS, 6×10 NORD,
10×10 PLUS, 12×10 PLUS



**Double hinged door
75 × 154 cm**

**HECHT 4×6 PLUS
GARDEN SHED
(dark grey)**
20 %
thicker material than
competition



**Maintenance free, high quality
metal construction, weatherproof.**

| | |
|------------------------------|--|
| base dimensions 184 × 109 cm | dimensions of the house incl. roof overhangs 195 × 121 × 180 cm |
| area 2,2 m ² | 0,3 mm board, 0,6 mm zinc steel frame |

20 %
thicker material than
competition

**HECHT 6×8 PLUS
GARDEN SHED
(dark grey)**



**Double hinged door
103 × 170 cm**

**Maintenance free, high-quality
metal construction, weatherproof.**

| | |
|------------------------------|--|
| base dimensions 184 × 248 cm | dimensions of the house incl. roof overhangs 258 × 196 × 208 cm |
| area 5 m ² | 0,3 mm board, 0,6 mm zinc steel frame |

20 %
thicker material
than competition

**HECHT 8×8 PLUS
GARDEN SHED
(dark grey)**



**Double hinged door
103 × 170 cm**

**Maintenance free, high-quality
metal construction, weatherproof.**

| | |
|------------------------------|--|
| base dimensions 248 × 248 cm | dimensions of the house incl. roof overhangs 258 × 260 × 208 cm |
| area 6,7 m ² | 0,3 mm board, 0,6 mm zinc steel frame |

20 %
thicker material
than competition

**HECHT 6×10 NORD
GARDEN SHED
(dark grey)**



**Transparent
window
69 × 71 cm**

**0,3–0,6 mm
coated board**

**Double hinged door
118 × 176 cm**

**Maintenance free, high-quality
metal construction, weatherproof.**

| | |
|------------------------------|--|
| base dimensions 290 × 162 cm | dimensions of the house incl. roof overhangs 302 × 172 × 229 cm |
| area 5,1 m ² | 0,6 mm zinc steel frame |

GARDEN SHEDS, SWIMMING POOLS

20 %
thicker material than
competition

HECHT 10×10 PLUS GARDEN SHED (dark grey)



**Double hinged door
125 × 170 cm**

**Maintenance free, high-quality
metal construction, weatherproof.**

base dimensions 291 × 291 cm

dimensions of the house incl. roof overhangs
303 × 301 × 214 cm

area 9 m²

0,3 mm board, 0,6 mm zinc steel frame

HECHT 3276 BLUESEA ANNULAR INFLATABLE POOL

Easy and quick installation



**Available
from 4/25**

**Connectable with cartridge
or sand filtration**

dimensions 300 x 76 cm

volume 3618 l

3 ply PVC material without the use of phthalates, repair kit included

HECHT 3476 BLUESEA ABOVE GROUND POOL

Steel tube frame



**Connectable with cartridge
or sand filtration**

dimensions 300 x 76 cm

volume 4383 l

3 ply PVC material without the use of phthalates, repair kit included

20 %
thicker material
than competition

HECHT 12×10 PLUS GARDEN SHED (dark grey)



**Double hinged door
125 × 170 cm**

**Maintenance free, high-quality
metal construction, weatherproof.**

base dimensions 355 × 291 cm

dimensions of the house incl. roof overhangs
367 × 301 × 214 cm

area 11 m²

0,3 mm board, 0,6 mm zinc steel frame

HECHT 3609 BLUESEA ANNULAR INFLATABLE POOL

Easy and quick installation



**Connectable with cartridge
or sand filtration**

dimensions 360 x 90 cm

volume 6654 l

3 ply PVC material without the use of phthalates, repair kit included

HECHT 3690 BLUESEA ABOVE GROUND POOL

Steel tube frame



**Connectable with cartridge
or sand filtration**

dimensions 360 x 76 cm

volume 6125 l

3 ply PVC material without the use of phthalates, repair kit included

POOL FILTRATIONS, CLEANER

HECHT 302222

10" SAND FILTRATION WITHOUT PREFILTER FOR ROUGH DIRT



| | |
|---------------------------|---------|
| voltage [V] | 220-240 |
| power [W] | 200 |
| sand capacity [kg] | 12 |
| water flow [m³/hod] | 4,5 |
| hose coupler [mm] | 32/38 |
| max. discharge height [m] | 7 |
| max. pool volume [m³]* | 20 |
| Certification GS/CE | |

7-way valve

Available from 4/24

HECHT 302111

10" SAND FILTRATION WITH PREFILTER FOR ROUGH DIRT



| | |
|---------------------------|---------|
| voltage [V] | 220-240 |
| power [W] | 250 |
| sand capacity [kg] | 12 |
| water flow [m³/hod] | 5,0 |
| hose coupler [mm] | 32/38 |
| max. discharge height [m] | 7,5 |
| max. pool volume [m³]* | 25 |
| Certification GS/CE | |

7-way valve

Available from 4/24

HECHT 302113

10" SAND FILTRATION WITH PREFILTER FOR ROUGH DIRT



| | |
|---------------------------|---------|
| voltage [V] | 220-240 |
| power [W] | 450 |
| sand capacity [kg] | 20 |
| water flow [m³/hod] | 6,0 |
| hose coupler [mm] | 32/38 |
| max. discharge height [m] | 10 |
| max. pool volume [m³]* | 30 |
| Certification GS/CE | |

7-way valve

Available from 4/25

HECHT 302016

16" SAND FILTRATION WITH PREFILTER FOR ROUGH DIRT



| | |
|---------------------------|---------|
| voltage [V] | 220-240 |
| power [W] | 550 |
| sand capacity [kg] | 45 |
| water flow [m³/hod] | 7,9 |
| hose coupler [mm] | 32/38 |
| max. discharge height [m] | 7,5 |
| max. pool volume [m³]* | 40 |
| Certification GS/CE | |

6-way valve

Coarse dirt filter

SAND TANK CAPACITY 45 KG

HECHT BLUESEA80

AUTOMATIC POOL VACUUM CLEANER



Li-ion
Powered



No need to connect to a filter unit

For above-ground and in-ground pools

| | | | | | |
|----|---|--------------|---|--------------------------------------|---------|
| ⚡ | voltage | DC 12,6 V | 📏 | max cleaning surface | 80 m² |
| 🔋 | battery | Li-ion, 5 Ah | 📐 | max. slope of the bottom of the pool | 15° |
| ⚡ | power | 50 W | 📏 | max depth | 2 m |
| 👤 | weight | 5,7 kg | 📏 | integrated filtration flow rate | 10 m³/h |
| 🌡️ | recommended water temperature | 18-32° C | 🕒 | max. working cycle | 90 min |
| 📄 | only cleans the bottom of the pool, built-in dirt collection basket | | 🕒 | charging time | 5-6 h |



POOL ACCESSORIES, LADDERS

HECHT 30003

SKIMMER

hose coupler [mm] 32/38
Complete mounting kit



Available from 4/25

HECHT 30004

SURFACE SKIMMER

hose coupler [mm] 32/38
Complete mounting kit



Available from 4/25

NEW

HECHT 003609

CARTRIDGE FILTRATION

voltage [V] 220-240
water flow [m³/hod] 1,2
hose coupler [mm] 32
Complete mounting kit

029587

REPLACEMENT FILTERS FOR CARTRIDGE FILTRATION – 2 PCS

Dimensions: 90 × 80 mm
Hole diameter: 48 mm



Available from 4/25



HECHT 305810

SOLAR COLLECTOR



dimensions [cm] 96x75
capacity [l] 12
max. pressure [bar] 1
hose coupler [mm] 32/38

Solar collector for water heating with a capacity of 12 liters. 38 mm hose flange. Possibility to adjust the feet towards the sun. Large area of 0,7 m² of high quality and durable material for fast heating of pool water.

HECHT 00090

LADDER FOR POOLS

width x height [cm] 138 × 135,5
Steel frame with surface finish and plastic treads (resistant to UV rays and pool chemicals)



HECHT 00091

SAFETY LADDER FOR POOLS

width x height [cm] 133 × 164

Steel frame with surface finish and plastic treads (resistant to UV rays and pool chemicals)



HECHT 00122

LADDER FOR POOLS

width x height [cm] 158 × 177

Steel frame with surface finish and plastic treads (resistant to UV rays and pool chemicals)



POOL ACCESSORIES

HECHT 060501
THERMOMETER



HECHT 060504
FLOATING THERMOMETER



HECHT 060510
THERMOMETER



HECHT 060511
THERMOMETER



HECHT 060512
THERMOMETER



HECHT 060301
LEAF SKIMMER
for surface-collecting debris



Available
from 4/25

HECHT 060302
LEAF SKIMMER
for surface-collecting debris



HECHT 060308
LEAF SKIMMER
for deep-collecting debris



HECHT 060309
LEAF SKIMMER
for deep-collecting debris
(reinforced frame)



HECHT 060307
LEVEL SKIMMER
ON ALUMINIUM ROD
length 1,3 m,
telescopic handle



Available
from 4/25

HECHT 06040218
180 cm RIBBED
ALUMINIUM POOL POLE
0.8 mm thickness
Available
from 4/25



HECHT 060402
TELESCOPIC ROD
two-parts 1,9 - 3,6 m



HECHT 060703
FLOATING CHLORINE
DISPENSER
200g



HECHT 060702
FLOATING CHLORINE
DISPENSER
(medium) 20g / 200g



HECHT 060705
FLOATING CHLORINE DISPENSER
WITH THERMOMETER
medium 20 / 200 g



HECHT 060203
BRUSH
for removing dirt from the
bottom and the edges
Dimension: 25 cm



HECHT 060205
BRUSH
for removing dirt from the
bottom and the edges
Dimension: 45 cm



HECHT 060104
TRIANGULAR VACUUM
cleaner 30 cm



HECHT 061002
POOL SERVICE KIT
4 PCS
Available
from 4/25



HECHT 060102
VACUUM CLEANER DE LUX
with side brushes



HECHT 060109
VACUUM CLEANER DE LUX - ALUMINIUM
width 30 cm



HECHT 060060
FOOT BASIN



HECHT 061210
REPAIR KIT
including glue and patches



Accessories for filtration pumps and solar collectors

HECHT 305811
3-WAY VALVE



HECHT 305813
3 × 32/38MM CONNECTORS
+ 3 × HOSE CLAMP

Available
from 4/25



HECHT 305812
32/38MM T-CONNECTOR + 3 × HOSE CLAMP



Available
from 4/25

HECHT 060607

4 IN 1 TEST STRIPS
for testing pH, total chlorine, free chlorine
and total water quality.



HECHT 060601

TESTER PH/CL
basic set for measuring
pH / CL in pool water.



Available
from 4/25

HECHT 000030
COVERING TARP
Ø 300 CM

HECHT 000036
COVERING TARP
Ø 360 CM

HECHT 000300
COVERING TARP
Ø 300 CM

HECHT 000360
COVERING TARP
Ø 360 CM

Available
from 4/25

Available
from 4/25



Drainage holes, pulling rope material PE 90 g/m²

Drainage holes, pulling rope material PE 90 g/m²

016123
UNDERLAY PAD FOR POOLS

HECHT 016124
UNDERLAY PAD FOR POOLS

dimensions [cm] 309×309
material PE [g/m²] 90

dimensions [cm] 390×390
material PE [g/m²] 90

| Solar tarps for pools | |
|-----------------------|------------|
| Nr. | Dimensions |
| HECHT 060250 | ø 2,5 m |
| HECHT 060300 | ø 3 m |
| HECHT 060360 | ø 3,6 m |



**MADE IN
CZECH
REPUBLIC**



**Thickness
180 µm**

INFRAASAUNAS - RELAX IN THE COMFORT OF YOUR HOME

HECHT ESSENTIAL

INFRAASAUNA



Color therapy



Towel holder



Oxygen ionizer



MP3 player,
radio



Glass door with
stylish
accessories

| | | | |
|-------------|-----------------------|-------------------------------|--------|
| dimensions | 1200 x 1150 x 1900 mm | power input | 2000 W |
| temperature | 30-60 °C | for 2 persons | ✓ |
| voltage | 230 V/50 Hz | ceramic heaters | ✓ |
| material | canadian hemlock | inner and outer control panel | ✓ |

MP3 player, full glass door, 5 heating elements, color therapy, oxygen ionizer, towel holder



HECHT FANTASY

INFRAASAUNA



Electric massage
stones



MP3 player,
radio



Color therapy



Oxygen ionizer

| | | | |
|-------------|-----------------------|--|--------|
| dimensions | 1800 x 1800 x 1900 mm | power input | 2800 W |
| temperature | 15-65 °C | for 2 persons | ✓ |
| voltage | 230 V/50 Hz | ceramic heater, carbon fiber heater | ✓ |
| material | canadian hemlock | inner and outer control panel | ✓ |

MP3 player, full glass door, 5+7 heating elements, control panel, tinted glass, made from canadian hemlock



HECHT 20020

INFRATED HEATED FLOOR

Infrared underfloor heating grid for HECHT Active and Essential, canadian hemlock, 104x37,5 cm, 180 W

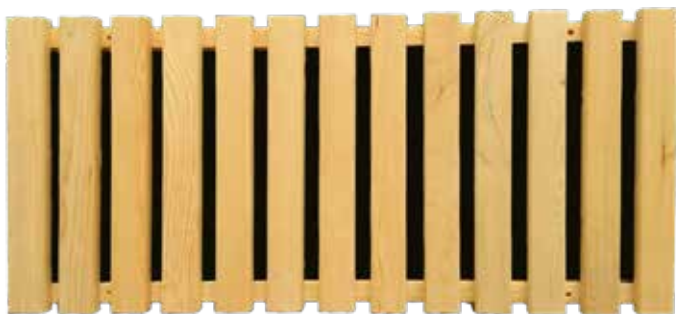

Benefits Of Infrared Sauna Therapy

- Internal temperature 30-60 °C
- Effective detoxification of organism
- Stress relieve
- Eliminates tiredness
- Cellulite prevention
- Skin purification - clearer, softer and healthier looking skin
- Strengthens immune system
- Pain relief (muscles, joints, back)
- Weight loss at 30 minutes up to 600 kcal
- Suitable for people with allergy, asthma, cardiac and blood pressure problems



TRAMPOLINES

HECHT 511001 LUXURY TRAMPOLINE Ø 3,05 m



STAIRS AND NET INCLUDED

INNER SAFETY NET

| | |
|---------------------------------|------------------|
| dimensions | Ø 305 × V 251 cm |
| max. load | 150 kg |
| jumping surface with 64 springs | |
| spring size | Ø 3,1 × 144 mm |



Complies with the strict EN-71 standard (child safety standard). Guaranteed load capacity of 150 kg during use (up to 550 kg load capacity). The wall thickness of the circumferential bars is 1.4 mm and the wall thickness of the support bars is 1.2 mm. A protective inner net around the perimeter of the trampoline protects the user from accidental contact with the springs. Modern rounded design. Access through a folded safety net – do not forget to close the net.

HECHT 512001 LUXURY TRAMPOLINE 3,66 m



STAIRS AND NET INCLUDED

INNER SAFETY NET

| | |
|---------------------------------|------------------|
| dimensions | Ø 366 × V 251 cm |
| max. load | 150 kg |
| jumping surface with 72 springs | |
| spring size | Ø 3,1 × 144 mm |



Complies with the strict EN-71 standard (child safety standard). Guaranteed load capacity of 150 kg during use (up to 550 kg load capacity). The wall thickness of the circumferential bars is 1.4 mm and the wall thickness of the support bars is 1.2 mm. A protective inner net around the perimeter of the trampoline protects the user from accidental contact with the springs. Modern rounded design. Access through a folded safety net – do not forget to close the net.

HECHT 514001 LUXURY TRAMPOLINE SUNK INTO THE GROUND 3,66 m



INNER SAFETY NET

Scheme of immersion of the trampoline in the ground

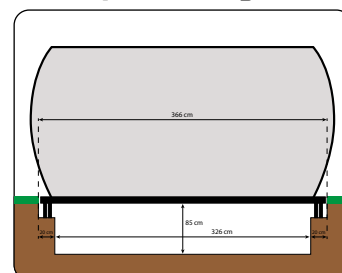

| | |
|---------------------------------|--------------------|
| dimensions | Ø 366 cm, V 203 cm |
| max. load | 150 kg |
| jumping surface with 72 springs | |
| spring size | Ø 3,1 × 144 mm |



Complies with the strict EN-71 standard (child safety standard). Guaranteed load capacity of 150 kg during use (up to 550 kg load capacity). The wall thickness of the circumferential bars is 1.4 mm and the wall thickness of the support bars is 1.2 mm. A protective inner net around the perimeter of the trampoline protects the user from accidental contact with the springs. Modern rounded design. Access through a folded safety net – do not forget to close the net.

FREE TIME

PEDAL CARS



HECHT 59788 PEDAL KART



| | | | | | |
|--|------------|-------------|------------------------------|-------------------|-----------|
| | dimensions | 94x63x51 cm | ✓ | for children aged | 3-8 years |
| | max. load | 25 kg | Pedal kart with chain drive. | | |
| | weight | 10,2 kg | | | |



HECHT 59789 PEDAL KART



| | | | | | |
|--|------------|-------------|------------------------------|-------------------|-----------|
| | dimensions | 94x63x51 cm | ✓ | for children aged | 3-8 years |
| | max. load | 25 kg | Pedal kart with chain drive. | | |
| | weight | 10,2 kg | | | |

NEW

HECHT 59791 RED PEDAL KART



Available from 5/25

| | | | | | |
|--|------------|-----------------|--|-------------------|-----------|
| | dimensions | 91 x 50 x 54 cm | ✓ | for children aged | 3-8 years |
| | max. load | 30 kg | Pedal kart with rubber wheels and chain drive. | | |
| | weight | 9 kg | | | |

NEW

HECHT 59792 GREEN PEDAL KART



Available from 5/25

| | | | | | |
|--|------------|-----------------|------------------------------|-------------------|-----------|
| | dimensions | 91 x 50 x 54 cm | ✓ | for children aged | 3-8 years |
| | max. load | 30 kg | Pedal kart with chain drive. | | |
| | weight | 9 kg | | | |



ORIGINAL LICENSED
ABARTH

**RIDING/
SKIDDING
MODE**



ABARTH RED/ WHITE/BLACK PEDAL KART



Adjustable seat

**Rubber wheels
30 cm**

Handbrake



139,99 €

| | | | | | |
|--|------------|--------------|-----------------------------|-------------------|-----------|
| | dimensions | 113x57x73 cm | ✓ | for children aged | 3-7 years |
| | max. load | 25 kg | Pedal kart with chain drive | | |
| | weight | 12,8 kg | | | |

aprilia

APRILIA DORSODURO 900

ORIGINAL LICENSED APRILIA



ACCU MOTORKA



ORIGINAL LICENSED BMW

BMW F 850 GS

ACCU MOTORKA



EVA wheels

| | | | | | |
|--|-------------------|--------------|-------------------------------|--------------|-------------|
| | dimensions | 108x48x71 cm | | accu | 12 V / 7 Ah |
| | max. load | 25 kg | | power output | 2x 18W |
| | weight | 14,6 kg | | speed | 3-5 km/h |
| | for children aged | 3-8 ani | MP3, light and sound effects. | | |

| | | | | | |
|--|-------------------|------------------|--|--------------|----------|
| | dimensions | 111 x 76 x 62 cm | | accu | 12 V |
| | max. load | 30 kg | | power output | 2x 35 W |
| | weight | 20 kg | | speed | 3-6 km/h |
| | for children aged | 3-8 ani | | | |



ORIGINAL LICENSED BMW

BMW R1200RT POLICE

ACCU BIKE



| | | | | | |
|--|-------------------|--------------------|---|--------------|-------------|
| | dimensions | 123,5 x 54 x 75 cm | | accu | 12 V / 7 Ah |
| | max. load | 30 kg | | power output | 35 W |
| | weight | 19,2 kg | | speed | 3-6 km/h |
| | for children aged | 3-8 years | Sound and light effects, MP3, start key, battery level indicator, storage compartment | | |

ACCESSORIES INCLUDES:

- Fireman hat
 - Functional water gun
 - Fire extinguisher
- The car is fitted with lights that flash like real fire truck.

HECHT 51818

ACCU CAR

10 Ah



| | | | | | |
|--|-------------------|------------------|------------------------------|--------------|--------------|
| | dimensions | 115 x 65 x 60 cm | | accu | 12 V / 10 Ah |
| | max. load | 30 kg | | power output | 2x 35 W |
| | weight | 20 kg | | speed | 3-4,5 km/h |
| | for children aged | 3-8 years | | | |
| | remote control | ✓ | Sound and light effects, MP3 | | |



| | | | | | |
|--|-------------------|--------------------|--|----------------------------------|----------------------|
| | dimensions | 160 x 65 x 68,5 cm | | accu | 12 V / 7 Ah, 2x 35 W |
| | max. load | 30 kg | | speed | 3,5 km/h |
| | for children aged | 3-8 years | | Sound and light effects, reverse | |

HECHT 50825 RED / GREEN

ACCU TRACTOR

7 Ah



The product meets strict standards for children's toys (EN 71-1, EN 71-2, EN 71-3, 2009/48/EC).

FREE TIME

ACCUCARS

HECHT 50435 WHITE / RED / GREEN

ACCU TRAKTOR

10 Ah



Available from 5/25

| | | | | | |
|--|-------------------|------------------|--|------------------------|-----------------------|
| | dimensions | 179 x 68 x 63 cm | | accu | 12 V / 10 Ah, 2x 35 W |
| | max. load | 30 kg | | speed | 3-5 km/h |
| | for children aged | 3-8 years | | MP3 & USB, Foam Wheels | |

HECHT 56189 RED / BLACK

ACCU CAR

NEW

10 Ah



Available from 5/25

| | | | | | |
|--|-------------------|-------------------|--|----------------|-------------|
| | dimensions | 96 x 59,5 x 61 cm | | accu | 12 V / 7 Ah |
| | max. load | 25 kg | | power output | 2x 35 W |
| | weight | 12,5 kg | | speed | 2-5 km/h |
| | for children aged | 3-8 years | | remote control | |

Light and sound effects, reverse, audio input.

HECHT 56185

ACCU CAR

10 Ah



| | | | | | |
|--|-------------------|------------------|--|----------------|--------------|
| | dimensions | 110 x 73 x 78 cm | | accu | 12 V / 10 Ah |
| | max. load | 30 kg | | power output | 2x 45 W |
| | weight | 17,5 kg | | speed | 3,2-6,8 km/h |
| | for children aged | 3-8 years | | remote control | |

Light and sound effects, reverse, big wheels, audio input.

HECHT 56187

ACCU CAR

10 Ah



| | | | | | |
|--|-------------------|------------------|--|----------------|--------------|
| | dimensions | 110 x 73 x 78 cm | | accu | 12 V / 10 Ah |
| | max. load | 30 kg | | power output | 2x 45 W |
| | weight | 17,5 kg | | speed | 3,2-6,8 km/h |
| | for children aged | 3-8 years | | remote control | |

Light and sound effects, reverse, big wheels, audio input.

JEEP WRANGLER RUBICON

Jeep ORIGINAL LICENSED JEEP WRANGLER RUBICON

10 Ah



| | | | | | |
|--|-------------------|------------------|--|--------------|--------------|
| | dimensions | 126 x 80 x 70 cm | | accu | 12 V / 10 Ah |
| | max. load | 35 kg | | power output | 2x 35 W |
| | for children aged | 3-8 years | | speed | 3-6 km/h |

Sound and light effects,, MP3, USB, SD.

ACCU CARS

HECHT 52108 RED/YELLOW ACCU FORKLIFT



10 Ah

| | | | | | |
|--|------------------------|-------------------|--------------------------|-------------------|--------------|
| | dimensions | 146 × 63 × 101 cm | | accu | 12 V / 10 Ah |
| | max. load | 35 kg | | power output | 2 × 40 W |
| | front dumper max. load | 10 kg | | max. speed | 2–6 km/h |
| | weight | 22,5 kg | | for children aged | 3–8 |
| | remote control | ✓ | USB, bluetooth, lighting | | |

CAT ORIGINAL LICENSED CAT

NEW



Available from 5/25

CAT UTV ACCU CAR



| | | | | | |
|--|-------------------|------------------|--|----------------|--------------|
| | dimensions | 126 × 76 × 72 cm | | accu | 12 V / 10 Ah |
| | max. load | 50 kg | | power output | 45 W |
| | weight | 26,4 kg | | speed | 3-7 km/h |
| | for children aged | 3-8 years | | remote control | ✓ |

Light and sound effects, reverse, big wheels, audio input.

BMW X6 WHITE/BLACK ACCU CAR



ORIGINAL LICENSED BMW



| | | | | | |
|--|-------------------|------------------|--|----------------|-------------|
| | dimensions | 116 × 74 × 60 cm | | accu | 12 V / 7 Ah |
| | max. load | 30 kg | | power output | 2x 35 W |
| | weight | 20 kg | | speed | 3-5 km/h |
| | for children aged | 3-8 years | | remote control | ✓ |

Sound and light effects, opening doors.

MERCEDES BENZ XMX606 RED / WHITE / POLICE / BLACK



ORIGINAL LICENSED MERCEDES

4x4 10 Ah

ACCU CAR



NEW

| | | | | | |
|--|-------------------|------------------|---|--------------|--------------|
| | dimensions | 141 × 78 × 66 cm | | accu | 12 V / 10 Ah |
| | max. load | 50 kg | | power output | 4 × 35 W |
| | for children aged | 3-8 years | | speed | 2-8 km/h |
| | remote control | ✓ | Sound and light effects, MP3, opening doors | | |



Speed and battery life depends on the terrain and the weight of the operator. The product meets strict standards for children's toys (EN 71-1, EN 71-2, EN 71-3, 2009/48/EC).

ACCU ATV – BIKES

HECHT 54300 RED / GREEN ACCU BIKE



| | | | | | |
|--|------------|------------------|--|---------------|----------------------|
| | dimensions | 110 × 60 × 70 cm | | accu | 36 V / 5,2 Ah, 300 W |
| | max. load | 60 kg | | max. speed | 16 km/h |
| | wheels | 12" | | charging time | 4-6 hours |
| | max. range | 17 km | | weight | 22 kg |

3 speeds, battery indicator

HECHT 54500 / 54501 / 54502 ACCU BIKE



| | | | | | |
|--|------------|------------------|--|---------------|--------------------|
| | dimensions | 125 × 56 × 80 cm | | accu | 36 V / 8 Ah, 500 W |
| | max. load | 75 kg | | max. speed | 7-25 km/h |
| | wheels | 10/10" | | charging time | 8 hours |
| | max. range | 20 km | | weight | 25 kg |

3 speeds, battery indicator, speed limit key, drive chain, front and rear disc brakes

HECHT 59100 ORANGE / GREEN / BLUE ACCU BIKE



| | | | | | |
|--|------------|--------------------|--|---------------|----------------------|
| | dimensions | 133 × 64 × 86,5 cm | | accu | 36 V / 12 Ah, 1000 W |
| | max. load | 65 kg | | max. speed | 28 km/h |
| | wheels | 12/10" | | charging time | 8-12 hours |
| | max. range | 15 km | | weight | 42 kg |

3 speeds, battery indicator, speed limit key, drive chain, front and rear disc brakes

ACCU AND PETROL ATV – BIKES

HECHT 59150 GREEN / BLUE / RED ACCU BIKE



| | | | | | |
|--|------------|------------------|--|---------------|------------------------|
| | dimensions | 147 × 64 × 92 cm | | accu | 48 V / 15,6 Ah, 1500 W |
| | max. load | 65 kg | | max. speed | 42 km/h |
| | wheels | 14/12" | | charging time | 8-12 hours |
| | max. range | 28 km | | weight | 39 kg |

3 speeds, battery indicator, speed limit key, drive chain, front and rear disc brakes

NEW



Semi-automatic four-speed transmission

HECHT 51125 RED / GREEN PETROL BIKE



| | | | | | |
|--|------------|-------------------------------|--|---------------|---------|
| | engine | 4-stroke, 125 cm ³ | | max. speed | 70 km/h |
| | output | 5 kW / 6,8 HP | | tank capacity | 3 l |
| | max. load | 70 kg | | weight | 57 kg |
| | dimensions | 165 x 74 x 110 cm | | wheels | 14/12" |

Chain drive, semiautomatic clutch, front / rear disc hydraulic brakes, e-start + kick start

NEW



Semi-automatic four-speed transmission

HECHT 51126 RED / GREEN PETROL BIKE



Available from 3/25

| | | | | | |
|--|------------|-------------------------------|--|---------------|---------|
| | engine | 4-stroke, 125 cm ³ | | max. speed | 70 km/h |
| | output | 5 kW / 6,8 HP | | tank capacity | 3 l |
| | max. load | 70 kg | | weight | 57 kg |
| | dimensions | 178 x 75 x 112 cm | | wheels | 17/14" |

Chain drive, semiautomatic clutch, front / rear disc hydraulic brakes, e-start + kick start

ACCU AND PETROL BUGGYS



HECHT 54879 RED PETROL BUGGY

NEW



Available from 3/25

| | | | | | |
|--|------------|------------------------------|--|---------------|-----------|
| | engine | 4-stroke, 79 cm ³ | | max. speed | 22 km/h |
| | output | 1,1 kW / 1,5 HP | | tank capacity | 1,4l |
| | max. load | 80 kg | | weight | 91 kg |
| | dimensions | 143 × 83 × 93 cm | | wheels | 13 × 5-6" |

1 speed forward, battery indicator



HECHT 54812 SILVER ACCU BUGGY



| | | | | | |
|--|------------|------------------|--|---------------|---------------------|
| | dimensions | 138 × 83 × 90 cm | | accu | 48 V / 12 Ah, 500 W |
| | max. load | 80 kg | | max. speed | 35 km/h |
| | wheels | 13 × 5-6" | | charging time | 8-10 hours |
| | max. range | 30 km | | weight | 73 kg |

3 settings of forward speed + 1 backward, battery indicator



HECHT 54812 RED ACCU BUGGY

NEW



Available from 3/25

| | | | | | |
|--|------------|------------------|--|---------------|----------------------|
| | dimensions | 138 × 83 × 90 cm | | accu | 48 V / 12 Ah, 1000 W |
| | max. load | 80 kg | | max. speed | 35 km/h |
| | wheels | 13 × 5-6" | | charging time | 8-10 hours |
| | max. range | 30 km | | weight | 73 kg |

3 settings of forward speed + 1 backward, battery indicator



HECHT 54899 SILVER ACCU BUGGY

| | | | | | |
|--|------------|-------------------|--|---------------|---------------------|
| | dimensions | 145 × 78 × 111 cm | | accu | 36 V / 12 Ah, 500 W |
| | max. load | 54 kg | | max. speed | 30 km/h |
| | wheels | 14 × 5-6" | | charging time | 8-12 hours |
| | max. range | 15-20 km | | weight | 68 kg |

Speed limit key switch, hand brake



HECHT 54849 RED ACCU BUGGY

NEW



Available from 3/25

| | | | | | |
|--|------------|------------------|--|---------------|----------------------|
| | dimensions | 137 x 87 x 92 cm | | accu | 48 V / 12 Ah, 1000 W |
| | max. load | 80 kg | | max. speed | 22 km/h |
| | wheels | 6" | | charging time | 6-8 hours |
| | max. range | 25 km | | weight | 91 kg |

3 settings of forward speed + 1 backward, battery indicator, front lights



HECHT 54100 RED / GREEN / BLUE ACCU QUAD



Digital display



| | | | | | |
|--|------------|------------------|--|---------------|----------------------|
| | dimensions | 100 × 59 × 60 cm | | accu | 36 V / 12 Ah, 1000 W |
| | max. load | 65 kg | | max. speed | 25 km/h |
| | wheels | 6" | | charging time | 8 hours |
| | max. range | 13-18 km | | weight | 42 kg |

3 speeds forward + 1 backward, safety pedal, battery indicator, drive - chain, speed limit key switch



Digital display

Front LED lights



HECHT 56100 RED / COMIC / ARMY ACCU QUAD

| | | | | | |
|--|------------|------------------|--|---------------|----------------------|
| | dimensions | 110 × 51 × 71 cm | | accu | 36 V / 12 Ah, 1000 W |
| | max. load | 65 kg | | speed | 20-25 km/h |
| | wheels | 6" | | charging time | 8 hours |
| | max. range | 13-18 km | | weight | 52 kg |

3 speeds forward + 1 backward, safety pedal, battery indicator, drive - chain, speed limit key switch



Chainless transmission



Front LED lights



Available from 2/25

| | | | | | |
|--|------------|------------------|--|---------------|----------------------|
| | dimensions | 115 × 68 × 52 cm | | accu | 48 V / 12 Ah, 1200 W |
| | max. load | 65 kg | | max. speed | 30 km/h |
| | wheels | 6" | | charging time | 8 hrs |
| | max. range | 15-20 km | | weight | 57 kg |

Chainless transmission, reverse, horn, battery indicator, brushless motor, disc brakes

ACCU QUADS

HECHT 51060 GREEN / BLUE / RED / YELLOW

ACCU QUAD



Pohon - diferenciál



Predné LED svetlá



| | | | | | |
|--|------------|------------------|--|---------------|----------------------|
| | dimensions | 118 × 70 × 71 cm | | accu | 36 V / 12 Ah, 1060 W |
| | max. load | 70 kg | | max. speed | 35 km/h |
| | wheels | 6" | | charging time | 8 hours |
| | max. range | 15-20 km | | weight | 57 kg |

Chainless drive, backward gear, horn, battery indicator



HECHT 56110

PETROL QUAD

7" wheels

NEW

**4-STROKE
110 CM³**

Available from 5/25



| | | | | | |
|--|------------|------------------------------|--|---------------|---------|
| | engine | 4-stroke, 110cm ³ | | max. speed | 55 km/h |
| | output | 4,9 kW / 6,6 HP | | tank capacity | 2 l |
| | max. load | 90 kg | | weight | 83,5 kg |
| | dimensions | 130 × 84 × 88 cm | | wheels | 7" |

Front LED lights, chain drive, front drum and rear disc brakes, electric starter (12 V / 5 Ah battery)



HECHT 56130

PETROL QUAD

8" wheels

NEW

**4-STROKE
125 CM³**

Available from 5/25



| | | | | | |
|--|------------|-------------------------------|--|---------------|---------|
| | engine | 4-stroke, 125 cm ³ | | max. speed | 55 km/h |
| | output | 6 kW / 8,1 HP | | tank capacity | 4,5 l |
| | max. load | 120 kg | | weight | 105 kg |
| | dimensions | 152 × 100 × 97 cm | | wheels | 8" |

Front LED lights, chain drive, front drum and rear disc brakes, electric starter (12 V / 5 Ah battery)



Front LED lights

**4-STROKE
125 CM³**



HECHT 56126 ARMY / RED

PETROL QUAD



| | | | | | |
|--|------------|-------------------------------|--|---------------|---------|
| | engine | 4-stroke, 125 cm ³ | | max. speed | 50 km/h |
| | output | 6 kW / 8,1 HP | | tank capacity | 2,5 l |
| | max. load | 120 kg | | weight | 95 kg |
| | dimensions | 148 × 108 × 102 cm | | wheels | 8" |

Front LED lights, chain drive, front drum and rear disc brakes, electric starter (12 V / 5 Ah battery)

HECHT 56150 ARMY / RED / HURON

ACCU QUAD



8" wheels



| | | | | | |
|--|-------------------------------|-------------------|--|---------------|----------------------|
| | dimensions | 145 x 102 x 96 cm | | accu | 60 V / 20 Ah, 1500 W |
| | max. load | 120 kg | | max. speed | 70 km/h |
| | calculated range | 42 km ** | | charging time | 8-10 hours |
| | real range at Ø 22km/h, 70 kg | 31 km | | weight | 131 kg |

2 gears, LED front light, towing device, front/rear seat, speedmeter, front drum / rear disc brakes



HECHT 56155 ARMY / RED / HURON

ACCU QUAD



Keyless



COC Certification

| | | | | | |
|--|----------------------------------|-------------------|--|---------------|----------------------|
| | dimensions | 154 x 105 x 99 cm | | accu | 72 V / 20 Ah, 1200 W |
| | max. load | 106 kg | | max. speed | 40 km/h |
| | calculated range | 46 km | | charging time | 8-10 hours |
| | real range at Ø 24,5 km/h, 70 kg | 39 km | | wheels | 8" |

COC, homologation for road use, rear hinge, alarm, keyless, LED display, 2 gears



HECHT 56199 ARMY / HURON

ACCU QUAD



Box size
96x55x40 cm

Storage box 82 l
obj. č. 561990128

| | | | | | |
|--|----------------------------------|-------------------|--|---------------|----------------------|
| | dimensions | 160 x 99 x 121 cm | | accu | 72 V / 20 Ah, 1200 W |
| | max. load | 120 kg | | max. speed | 45 km/h |
| | calculated range | 54 km | | charging time | 7-10 hours |
| | real range at Ø 24,5 km/h, 70 kg | 39 km | | brakes | disc / disc |

COC, homologation for road use, rear hinge, alarm, keyless, LED display, box 82 l, LED lights



COC Certification

Keyless
Digital display

LEISURE TIME

HECHT 59399 ARMY / RED / HURON

ACCU QUAD



Keyless start/stop



Rear hinge



COC Certification



Rear disc brakes



| | | | | | |
|--|--------------------------------|--------------------|--|---------------|----------------------|
| | dimensions | 184 x 111 x 110 cm | | accu | 72 V / 52 Ah, 2200 W |
| | max. load | 220 kg | | max. speed | 45 km/h |
| | calculated range | 70 km | | charging time | 8-15 hours |
| | real range at Ø 35 km/h, 70 kg | 60 km | | wheels | 10" |

COC, homologation for road use, rear hinge, LED display, front and rear rack, 1 gear

HECHT FARMIS

CARGO ACCU QUAD

Tilting body up to 30°



www.hecht.cz

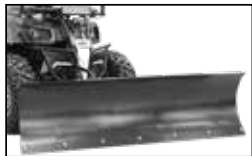

| | | | | | |
|--|----------------------------------|----------------------|--|-------------------------------------|----------------------|
| | battery | 72 V / 52 Ah, 3000 W | | cargo bed dimensions | 150 x 110 x 43 cm |
| | max. power | 3 kW | | wheelbase | 186 cm |
| | max. speed | 53 km/h | | wheels front / rear | 25x8-12" / 25x10-12" |
| | weight | 424 kg | | brakes front / rear | double disc |
| | max. load | 475 kg | | calculated range on a single charge | 66,14 km ** |
| | max. incline with / without load | 20 / 30° | | 2WD drive | |

HECHT CARGO

CARGO ACCU QUAD



COC Certification

Tilting body up to 30°



| | | | | | |
|--|-------------------------------|----------------------|--|--|----------------------|
| | battery | 72 V / 62 Ah, 3000 W | | cargo bed dimensions | 150 x 110 x 35 cm |
| | max. power | 3 kW | | wheelbase | 190 cm |
| | max. torque | 9,1 Nm | | wheels front / rear | 25x8-12" / 25x10-12" |
| | max. speed | 50 km/h | | brakes front / rear | disc |
| | weight | 498 kg | | consumption | 94 Wh/km |
| | max. load / max. total weight | 320 / 818 kg | | measured/calculated range on a single charge | 46/74,7 km ** |
| | max. incline | 30° | | rear-wheel drive, homologation for road use, winch | |

| Accessories | Order no. | Intended for models |
|-------------|---------------|---------------------------|
| Ploughshare | HECHT0059399R | HECHT FARMIS, HECHT CARGO |

ATV AND SCOOTER ACCESSORIES, E-BICYCLES

ATV BAGS

HECHT 52002 BLACK

70x30x31 cm

Suitable for HECHT 59399



Waterproof, PE board, Velcro straps with reflective elements

HECHT 0054700

FLAG FOR ATVS



HECHT batteries

Leaded, maintenance-free batteries for toy cars, quads, scooters and lawnmowers with e-start.



| Order No. | Battery | Intended for use with model | Dimensions in mm |
|--------------|--------------|---|------------------|
| 561810030 | 6 V / 7 Ah | 2 pcs – BMWX6 | 151x35x93 |
| 561850030 | 6 V / 10 Ah | 2 pcs – 56185, 56787 | 151x51x94 |
| 005484 | 12 V / 4 Ah | 1 pc – 543 SWE, 548 SWE, 5483 SWE, 5484 SXE, 5534 SWE, 5543 SXE | 91x71x105 |
| 005564 | 12 V / 9 Ah | 1 pc – 5563 SXE, 5564 SXE, 5161, Aprilia Dorsoduro 900, BMW S1000RR, BMW R1200RT 2 pcs – Ford Ranger MT | 151x65x94 |
| 545000087 | 12 V / 9 Ah | 3 pcs – 54500, 54501, 54502 | 151x65x94 |
| 548000066 | 12 V / 12 Ah | 3 pcs – 50925, 51818, 55999, JeepWrangler, FordRanger, 52108, MercedesBENZMX606, 59100, 54899, 54803, 54800, 54801, 56801, 56800, 56800COMIC, 51060, 4 pcs – 54812 | 151x98x96 |
| 703110014(E) | 12 V / 20 Ah | 5 pcs – 56150, Grace 6 pcs – 56155, Equis, Citis, CitisMax | 181x77x167 |
| 593990013(E) | 12 V / 52 Ah | 6 pcs – 59399, Farmis | 180x225x136 |



SHIMANO

HECHT RUNNIS RED E-BIKE



Price including battery

Available from 5/25

| | | | | | |
|--|---------------------|-----------|--|----------------|------------------------|
| | frame | 26" steel | | battery Li-ion | 36 V / 10,4 Ah / 250 W |
| | wheels | 26x1,75" | | max. load | 100 kg |
| | range up to | 85 km * | | charging time | 5-6 hrs |
| | max. speed assisted | 25 km/h | | weight | 23 kg |

derailleur SHIMANO ARDTZ500GSD, 6 gears, rear carrier, front light, chain wheel cover, V brakes, stand



SHIMANO

HECHT RUNNIS BLUE E-BIKE



Price including battery

Available from 5/25

| | | | | | |
|--|---------------------|-----------|--|----------------|------------------------|
| | frame | 26" steel | | battery Li-ion | 36 V / 10,4 Ah / 250 W |
| | wheels | 26x1,75" | | max. load | 100 kg |
| | range up to | 85 km * | | charging time | 5-6 hrs |
| | max. speed assisted | 25 km/h | | weight | 23 kg |

derailleur SHIMANO ARDTZ500GSD, 6 gears, rear carrier, front light, chain wheel cover, V brakes, stand



SHIMANO

HECHT RUNNIS SHADOW E-BIKE



Price including battery

Available from 5/25

| | | | | | |
|--|---------------------|-----------|--|----------------|------------------------|
| | frame | 26" steel | | battery Li-ion | 36 V / 10,4 Ah / 250 W |
| | wheels | 26x1,75" | | max. load | 100 kg |
| | range up to | 85 km * | | charging time | 5-6 hrs |
| | max. speed assisted | 25 km/h | | weight | 23 kg |

derailleur SHIMANO ARDTZ500GSD, 6 gears, rear carrier, front light, chain wheel cover, V brakes, stand



SHIMANO

HECHT PRIME GREY E-BIKE



LCD DISPLAY



DISC BRAKES

Available from 5/25

| | | | | | |
|--|---------------------|------------------|--|--------------------|------------------------|
| | frame | 18" aluminium | | battery Li-ion | 36 V / 11,6 Ah / 250 W |
| | wheels | 26 x 1,75" WANDA | | weight / max. load | 120 kg |
| | range up to | 85 km * | | charging time | 4-5 hrs |
| | max. speed assisted | 25 km/h | | weight | 25,2 kg |

disc brakes, derailleur SHIMANO TOURNEY ARDTZ500GSD, 7 gears, front and rear carrier, front light, chain cover

E-BICYCLES



HECHT PRIME RED / WHITE

E-BIKE

SHIMANO



LCD DISPLAY

DISC BRAKES



Available from 5/25

Price including battery

| | | | | | |
|--|---------------------|------------------|--|--------------------|------------------------|
| | frame | 18" aluminium | | battery Li-ion | 36 V / 11,6 Ah / 250 W |
| | wheels | 26 x 1,75" WANDA | | weight / max. load | 120 kg |
| | range up to | 85 km * | | charging time | 4-5 hrs |
| | max. speed assisted | 25 km/h | | weight | 25,2 kg |

disc brakes, derailleur SHIMANO TOURNEY ARDTZ500GSD, 7 gears, front and rear carrier, front light, chain cover



HECHT COMPOS MINI MATT GREY / BLACK WHITE

E-BIKE

Price including battery
Internal battery
Folding frame



Available from 6/25

AVAILABLE ACCESSORY - HECHT COMPOS MINI BAG

| | | | | | |
|--|---------------------|---------------|--|--------------------|-----------------------|
| | frame | 16" magnesium | | battery Li-ion | 36 V / 7,8 Ah / 250 W |
| | wheels | 16x2,4" | | weight / max. load | 100 kg |
| | range up to | 40 * | | charging time | 3-4 hrs |
| | max. speed assisted | 25 km/h | | weight | 20,8 kg |

disc brakes, 1 gear



SHIMANO

HECHT COMPOS GREY / BLUE

Folding frame

More colors available

Price including battery



SHIMANO

HECHT COMPOS XL GREY / BLUE

Folding frame

More colors available

Price including battery



| | | | | | |
|--|-------------|-----------|--|---------------------|----------------------|
| | frame | 20" alloy | | battery Li-ion | 36 V / 10 Ah / 250 W |
| | wheels | 20" | | charging time | 5-6 hrs |
| | range up to | 80 km * | | max. speed assisted | 25 km/h |

derailleur SHIMANO TOURNEY RDTY300D, 7 gears, rear carrier, bottle holder, disc brakes, front and rear light, stand, bell

| | | | | | |
|--|-------------|---------------|--|---------------------|----------------------|
| | frame | 20" alloy | | battery Li-ion | 36 V / 13 Ah / 250 W |
| | wheels | 20x4.0" KENDA | | charging time | 5-6 hrs |
| | range up to | 80 km * | | max. speed assisted | 25 km/h |

derailleur SHIMANO TOURNEY RDTY300D, 7 gears, rear carrier, disc brakes, front and rear light, stand, bell



SHIMANO

HECHT GRIMIS MATT

E-BIKE

LCD DISPLAY



Available from 5/25

Price including battery

| | | | | | |
|--|---------------------|---------------|--|----------------|----------------------|
| | frame | 18" aluminium | | battery Li-ion | 36 V / 15 Ah / 250 W |
| | wheels | 27,5x2,1" | | max. load | 100 kg |
| | range up to | 115 km * | | charging time | 6-7 hrs |
| | max. speed assisted | 25 km/h | | weight | 20,5 kg |

front suspension, derailleur SHIMANO ALTUS ARDM310DLC, 21 gears, disc brakes



SHIMANO

HECHT LEONIS GREY

Internal battery



Available from 5/25

Price including battery

| | | | | | |
|--|-------------|----------------|--|---------------------|------------------------|
| | frame | 29" 700C alloy | | battery Li-ion | 36 V / 14,5 Ah / 250 W |
| | wheels | 28" KENDA | | charging time | 5-6 hrs |
| | range up to | 120 km * | | max. speed assisted | 25 km/h |

derailleur SHIMANO ARDM310DLC, 8 gears, rear carrier, disc brakes, stand

E-SCOOTERS



HECHT 5177 E-SCOOTER

Li-ion Powered



HECHT 5299 E-SCOOTER

Li-ion Powered

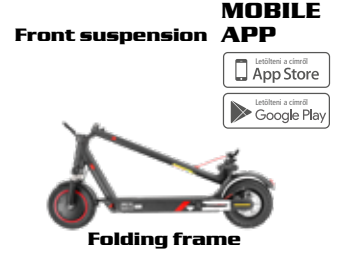

| | | | | | |
|-----|---------------------|------------|----|--|-----------------------|
| ALU | frame | aluminium | 🔋 | battery | 36 V / 7,5 Ah / 350 W |
| 🛞 | wheels | 8,5" | ⚡ | climbing capacity | 11 ° |
| 🚶 | range up to | 25 km * | 🕒 | charging time | 3-5 hrs |
| 🕒 | max. speed assisted | 25 km/h | 🏋️ | weight | 12 kg |
| 🚶 | max. load | 100 kg | 🔊 | motor | front |
| 🛞 | brakes | rear, disc | ✓ | Integrated light, stand, honeycomb tires | |

| | | | | | |
|-----|---------------------|-----------|----|---|----------------------|
| ALU | frame | aluminium | 🔋 | battery | 36 V / 10 Ah / 400 W |
| 🛞 | wheels | 10,5" | ⚡ | climbing capacity | 11° |
| 🚶 | range up to | 35 km * | 🕒 | charging time | 5-6 hrs |
| 🕒 | max. speed assisted | 25 km/h | 🏋️ | weight | 15 kg |
| 🚶 | max. load | 120 kg | 🔊 | motor | front |
| 🛞 | brakes | disc | ✓ | Front suspension, integrated light, stand | |



HECHT 5201 BLACK / ORANGE E-SCOOTER



Li-ion Powered

- Stand included
- Storage box
- Easy folding

| | | | | | |
|-----|-------------------|---------|----|--|-----------------------|
| ALU | frame | steel | 🔋 | battery | 48 V / 10 Ah / 1000 W |
| 🛞 | wheels | 10/10" | ⚡ | climbing capacity | 15 ° |
| 🚶 | range up to | 50 km * | 🕒 | charging time | 6-8 hours |
| 🕒 | max. speed | 50 km/h | 🏋️ | weight | 32,5 kg |
| 🚶 | max. load | 120 kg | 🔊 | motor | back |
| 🛞 | brakes front/rear | disc | ✓ | Integrated light, stand, shock absorber, digital display | |



HECHT 5485 E-SCOOTER

NEW

- Stand included
- Storage box
- Easy folding



Display digital

Available from 5/25

| | | | | | |
|-----|---------------------|---------|----|--|----------------------|
| ALU | frame | steel | 🔋 | battery | 48 V / 15 Ah / 500 W |
| 🛞 | wheels | 14/14" | ⚡ | climbing capacity | 15 ° |
| 🚶 | range up to | 65 km | 🕒 | charging time | 6-8 hours |
| 🕒 | max. speed assisted | 45 km/h | 🏋️ | weight | 31,1 kg |
| 🚶 | max. load | 120 kg | 🔊 | motor | back |
| 🛞 | brakes | disc | ✓ | Integrated light, stand, shock absorber, digital display | |

Speed and battery life depends on the terrain and the weight of the operator.

E-SCOOTERS

HECHT 5488 E-SCOOTER



Stand included
Folding frame

| | | | | | |
|--|-------------------|-----------------------|--|--|-----------|
| | battery Li-ion | 48 V / 18 Ah / 1200 W | | max. speed assisted | 45 km/h |
| | wheels | 10,5" | | charging time | 10-12 hrs |
| | range up to | 60 km * | | weight | 26 kg |
| | max. load | 100 kg | | motor | back |
| | brakes front/back | disc | | front suspension, digital display, stand | |

HECHT TERRIS WHITE / BLACK FOLDABLE E-SCOOTER



COC Certification



2x front light



Folding frame



Digital display



Front and rear suspension



Anti-slip board

| | | | | | |
|--|------------------------------|-----------|--|--|--------------|
| | power | 3000 W | | battery | 60 V / 20 Ah |
| | tubeless tyres | 145/70-6" | | max. speed | 45 km/h |
| | range up to | 50 km * | | charging time | 8-12 hours |
| | technically permissible load | 150 kg | | weight | 55 kg |
| | brakes front/rear | disc | | removable seat, metal wheel trim, two front lights | |

HECHT 00513

ADDITIONAL BASKET



COC Certification



electromotor

40 km

∞

Thanks to the pedals it is possible to adapt the riding style like on an e-bike with minimal effort and thus increase the overall range or performance.



LCD display

Large wheels and shock absorbers make it easier to drive off-road and on dirt roads

| | | | | | |
|--|----------------|--------------------------|--|---------------------------|--------------|
| | power | 800 W | | battery | 48 V / 12 Ah |
| | tubeless tyres | 14" x 2,25 14" x 2,25 | | max. speed | 45 km/h |
| | max. range | 40 km | | charging time | 6-7 h |
| | brakes | disc / disc | | weight incl. batteries | 58 kg |
| | dimensions | 170 x 62 x 105 cm | | Front and rear suspension | |

Speed and battery life depends on the terrain and the weight of the operator.

HELMETS

HELMETS for ATV

Product conforms to relevant EU standards.
European homologation.
Material: ABS
Weight: 1320 g (±50)

| Sizes/Head circumference | |
|--------------------------|----------|
| XS | 53-54 cm |
| S | 55-56 cm |
| M | 57-58 cm |
| L | 59-60 cm |
| XL | 61-62 cm |

Removable and washable insert, clamping strap with quick coupling, adjustable peak. Smooth finishing with high-quality varnishing, cloth bag.



XS, S, M, L, XL



S, M



XS, S

HECHT 54915



XS, S, M, L

HECHT 51915



XS, S, M

HECHT 55915



XS, S, M, L, XL

HELMETS for scooters

Product conforms to relevant EU standards.
European homologation



Flip-up front part, openable visor, adjustable inner shade.

Available from 4/25

HECHT 51925



NEW

XS, S, M, L, XL

HECHT 52925



NEW

M, L, XL

HECHT 53925



NEW

M, L, XL

HECHT 51631, 52631, 53631
- Head circumference

| | |
|----|----------|
| XS | 53-54 cm |
| S | 55-56 cm |
| M | 57 cm |
| L | 58 cm |
| XL | 59 cm |

HECHT 51631



XS, S, M, L, XL

HECHT 52631



M, L, XL

HECHT 53631



L, XL

HECHT 52588, 51588, 51627, 52627, 53627
- Head circumference

| | |
|----|----------|
| XS | 53-54 cm |
| S | 55-56 cm |
| M | 57-58 cm |
| L | 59-60 cm |
| XL | 61 cm |

HECHT 52588



S, M

HECHT 51627



S, M, L, XL

HECHT 52627



XS, S, M, L, XL

Removable and washable insert (excluding HECHT 51631, 52631 and 53631 models), clamping strap with quick coupling, adjustable peak. High quality finish.

Adjustable inner shade

Speed and battery life depends on the terrain and the weight of the operator.

E-SCOOTERS

HECHT COCIS MINI RED / BLACK / CARBON

E-SCOOTER

Available from 4/25



COC Certification



| | | | | | |
|--|-------------------|-------------|--|----------------------------------|--------------|
| | power | 1000 W | | battery | 48 V / 13 Ah |
| | tubeless tyres | 14x6.00-10" | | max. speed | 42 km/h |
| | max. range | 35 km | | charging time | 6-8 hours |
| | max. load | 115 kg | | weight | 37 kg |
| | brakes front/rear | disc | | front LED light, digital display | |

HECHT EQUIS BLACK / WHITE

E-SCOOTER

www.hecht.cz



Digital display



Storage place under the seat



COC Certification

| | | | | | |
|--|------------------------------|--------------------------|--|------------------------------|--------------|
| | power | 3000 W | | battery | 72 V / 20 Ah |
| | tubeless tyres | 110/70-12" 110/70-12" | | climbing capacity | 15 ° |
| | max. range | 60 km | | max. speed | 45 km/h |
| | technically permissible load | 271 kg | | charging time | 6-8 hours |
| | brakes | disc/disc | | weight incl. batteries | 121 kg |
| | front and rear suspension | | | storage place under the seat | |

HECHT CITIS WHITE / BLUE

E-SCOOTER



COC Certification



Digital tachometer



| | | | | | |
|--|------------------------------|--------------------------|--|------------------------|--------------|
| | power | 3000 W | | battery | 72 V / 20 Ah |
| | tubeless tyres | 110/70-12" 110/70-12" | | max. speed | 45 km/h |
| | max. range | 60 km | | charging time | 8 hours |
| | technically permissible load | 279 kg | | weight incl. batteries | 130 kg |
| | brakes | disc / disc | | | |

Speed and battery life depends on the terrain and the weight of the operator.

E-SCOOTERS, SENIOR WHEELCHAIRS

HECHT VISTA

ELECTRIC SENIOR WHEELCHAIR



COC Certification



Digital tachometer

NEW



Available from 3/25

| | | | | | |
|--|------------------------------|-------------------|--|------------------------|--------------|
| | power | 1000 W | | battery | 60 V / 20 Ah |
| | tubeless tyres | 3.0x10" | | max. speed | 25 km/h |
| | max. range | 40-60 km | | charging time | 6-8 h |
| | technically permissible load | 150 kg | | weight incl. batteries | 107 kg |
| | dimensions | 155 x 69 x 110 cm | | brakes | disc/hub |

HECHT CITIS MAX

SHADOW / BLUE / WHITE / RED

ELECTRIC SENIOR WHEELCHAIR



COC Certification



Digital tachometer



| | | | | | |
|--|------------------------------|---------------------|--|------------------------|-------------------|
| | power | 800 W | | battery | 60 V / 20 Ah |
| | tubeless tyres | 3.00-10", 3.00-10" | | max. speed | 15 / 20 / 25 km/h |
| | max. range | 60 km | | charging time | 8 hours |
| | technically permissible load | 211 kg | | weight incl. batteries | 111 kg |
| | dimensions | 155,5 x 70 x 109 cm | | brakes | drum / drum |

HECHT WISE BLUE / RED

ELECTRIC SENIOR WHEELCHAIR



HECHT 00413
ADDITIONAL BASKET



| | | | | | |
|--|------------|-------------------|--|----------------------|--------------|
| | power | 500 W | | battery | 24 V / 40 Ah |
| | dimensions | 140 x 69 x 126 cm | | max. speed | 15 km/h |
| | max. range | 42 km | | climbing capacity | 20 ° |
| | max. load | 150 kg | | weight incl. battery | 108 kg |
| | wheels | 4,10 / 3,50-6" | | | |

HECHT ELEGANTE

ELECTRIC SENIOR WHEELCHAIR



COC Certification



Digital tachometer

NEW



HECHT 00414
ADDITIONAL CRUTCH HOLDER
Available from 3/25

Available from 3/25



| | | | | | |
|--|------------------------------|-------------------|--|------------------------|--------------|
| | power | 1000 W | | battery | 60 V / 20 Ah |
| | tubeless tyres | 3.0x8" | | max. speed | 25 km/h |
| | max. range | 40-60 km | | charging time | 6-8 h |
| | technically permissible load | 150 kg | | weight incl. batteries | 119 kg |
| | dimensions | 160 x 67 x 114 cm | | brakes | disc |

E-MOBILITY

CAT SCRATCHING POSTS

PROMINENT MINNIE B

(beige)

NEW

Ø 65 mm



Available from 2/25

| | | | |
|-------|----------------------|-------|------|
| plush | 400 g/m ² | sisal | 4 mm |
|-------|----------------------|-------|------|

PROMINENT MINNIE S

(grey)

NEW

Ø 65 mm



Available from 2/25

| | | | |
|-------|----------------------|-------|------|
| plush | 400 g/m ² | sisal | 4 mm |
|-------|----------------------|-------|------|

PROMINENT MIA B

(beige)

NEW

Ø 65 mm

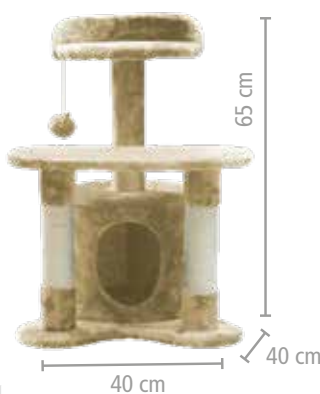

Available from 2/25

| | | | |
|-------|----------------------|-------|------|
| plush | 350 g/m ² | sisal | 4 mm |
|-------|----------------------|-------|------|

PROMINENT MIA S

(grey)

NEW

Ø 65 mm

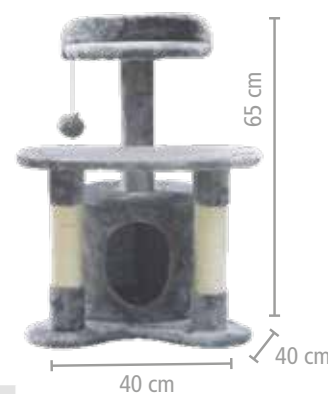

Available from 2/25

| | | | |
|-------|----------------------|-------|------|
| plush | 350 g/m ² | sisal | 4 mm |
|-------|----------------------|-------|------|

PROMINENT LAZY B

(beige)

NEW

Ø 65 mm



Available from 2/25

| | | | |
|--------------|----------------------|-------|------|
| plush/velvet | 400 g/m ² | sisal | 4 mm |
|--------------|----------------------|-------|------|

PROMINENT LAZY S

(grey)

NEW

Ø 65 mm

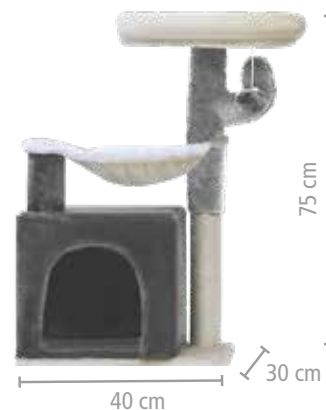

Available from 2/25

| | | | |
|--------------|----------------------|-------|------|
| plush/velvet | 400 g/m ² | sisal | 4 mm |
|--------------|----------------------|-------|------|

PROMINENT DAISY B

(beige)

NEW

Ø 65 mm

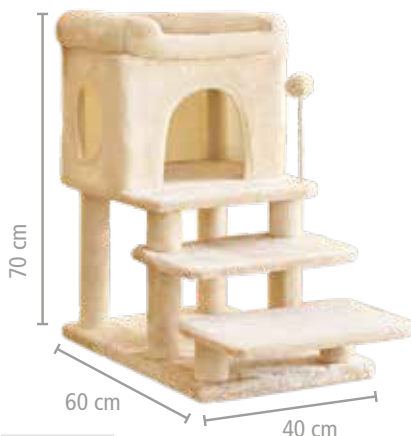

Available from 2/25

| | | | |
|-------|----------------------|-------|------|
| plush | 400 g/m ² | sisal | 4 mm |
|-------|----------------------|-------|------|

PROMINENT DAISY S

(grey)

NEW

Ø 65 mm

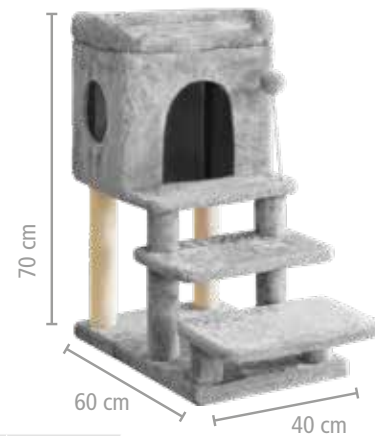

Available from 2/25

| | | | |
|-------|----------------------|-------|------|
| plush | 400 g/m ² | sisal | 4 mm |
|-------|----------------------|-------|------|

CAT SCRATCHING POSTS

PROMINENT LUNA B (beige)

Ø 70 mm



plush 400 g/m² sisal 4 mm 48 cm

PROMINENT LUNA S (grey)

Ø 70 mm



plush 400 g/m² sisal 4 mm 48 cm

PROMINENT NALA B (beige)

Ø 85 mm



plush 400 g/m² sisal 4 mm 50 cm

PROMINENT NALA S (grey)

Ø 85 mm



plush 400 g/m² sisal 4 mm 50 cm

PROMINENT SIMBA B (beige)

Ø 145 mm



plush 400 g/m² sisal 4 mm 55 cm

PROMINENT SIMBA S (grey)

Ø 145 mm



plush 400 g/m² sisal 4 mm 55 cm

PROMINENT PERSIAN B (beige)

Ø 145 mm



plush 400 g/m² sisal 4 mm 60 cm

PROMINENT PERSIAN S (grey)

Ø 145 mm



plush 400 g/m² sisal 4 mm 60 cm

GARFIELD B (beige)

Suitable for
Maine-coon cats

Ø 125 mm



plush 400 g/m² sisal 6 mm 65 cm

GARFIELD S (grey)

Suitable for
Maine-coon cats

Ø 125 mm



plush 400 g/m² sisal 6 mm 65 cm

ANIMAL HOUSES

PROMINENT HOLIDAY

RABBIT CAGE WITH PADDOCK

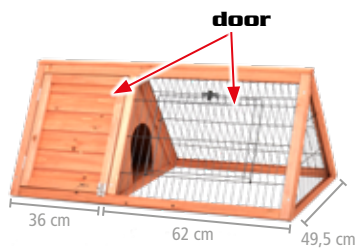

Available from 2/25

| | | |
|----------------------------|------------|-----------------|
| | dimensions | 98 x 50 x 41 cm |
| Made from durable fir wood | | |
| Without ground wires | | |

PROMINENT MICKEY

RABBIT CAGE



Available from 2/25

| | | |
|-----------------------------------|------------|-------------------|
| | dimensions | 91,5 x 45 x 70 cm |
| Made from durable fir wood | | |
| Roof covered with asphalt shingle | | |

PROMINENT BUNNY

RABBIT CAGE



Available from 2/25

| | | |
|---|------------|--------------------|
| | dimensions | 111,5 x 45 x 92 cm |
| Made from durable fir wood | | |
| Roof covered with asphalt shingle, Without ground wires | | |

PROMINENT MOLLY

RABBIT CAGE

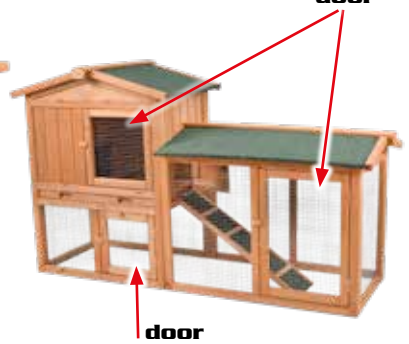

Available from 2/25

| | | |
|---|------------|----------------------|
| | dimensions | 147 x 52,8 x 85,5 cm |
| Made from durable fir wood | | |
| Roof covered with asphalt shingle, Without ground wires | | |

PROMINENT RAPHAELO

TWO-LEVEL RABBIT CAGE



Available from 2/25

| | | |
|----------------------------|------------|-------------------|
| | dimensions | 101 x 55 x 100 cm |
| Made from durable fir wood | | |

PROMINENT SALLY

TWO-LEVEL RABBIT CAGE



| | | |
|----------------------------|------------|-------------------|
| | dimensions | 104 x 50 x 104 cm |
| Made from durable fir wood | | |

PROMINENT OLIVER

HENHOUSE

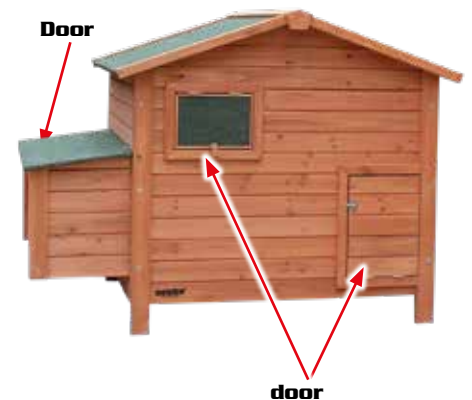

| | | | |
|----------------------------|------------|------------------|-----------------------------------|
| | dimensions | 134 x 90 x 99 cm | Without ground wires |
| Made from durable fir wood | | | Roof covered with asphalt shingle |

PROMINENT OREO

HENHOUSE

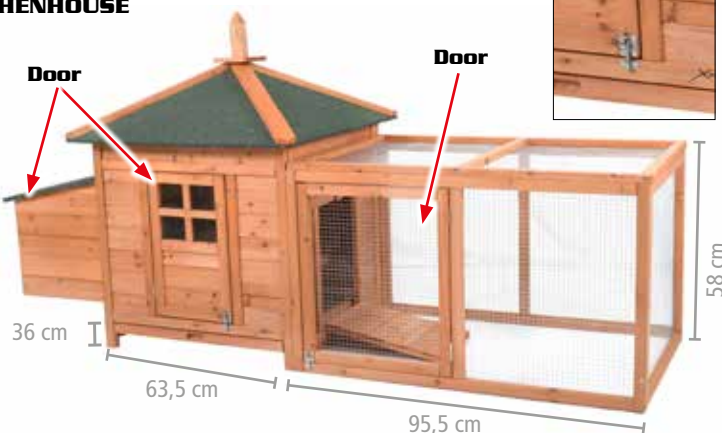

| | | | | |
|----------------------|------------|----------------------------|-----------------------------------|--------|
| | dimensions | 195 x 73 x 98 cm | wires thickness | 0,7 mm |
| wood thickness | | 20 mm | Roof covered with asphalt shingle | |
| Without ground wires | | Made from durable fir wood | | |

PROMINENT TWEETY

HENHOUSE

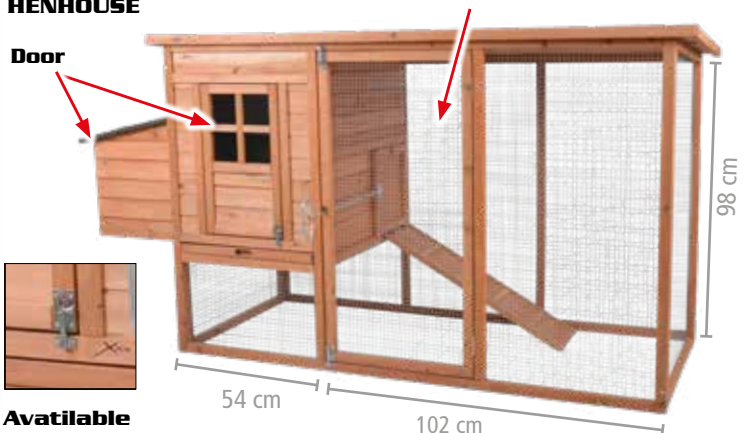

| | | | | |
|-----------------------------------|------------|----------------------|-----------------|-----------------|
| | dimensions | 198 x 75 x 102,5 cm | wires thickness | 0,7 mm |
| wood thickness | | 20 mm | side box | 61 x 32 x 40 cm |
| Made from durable fir wood | | Without ground wires | | |
| Roof covered with asphalt shingle | | | | |

www.hecht.cz

PROMINENT EMILY 3 FLOOR WOODEN RABBIT HUTCH



dimensions 91,5 x 45 x 116 cm

Made from durable fir wood

Roof covered with asphalt shingle,
Without ground wires

Available
from 2/25

PROMINENT CONNIE RABBIT HUTCH

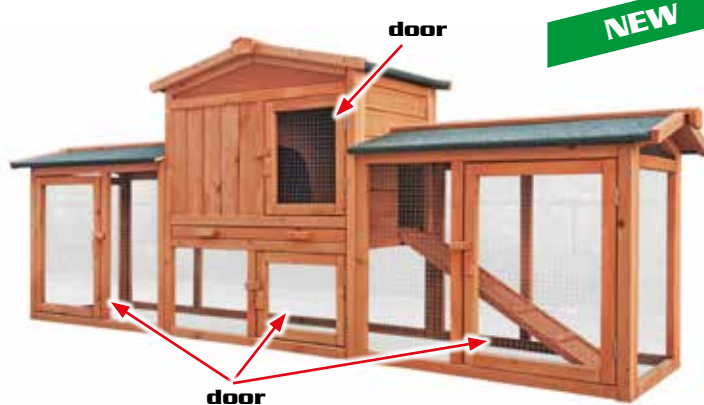

dimensions 211 x 53 x 83,5 cm

Made from durable fir wood

Roof covered with asphalt shingle,
Without ground wires

Available
from 2/25

PROMINENT CLAUDIE TWO-LEVEL RABBIT CAGE

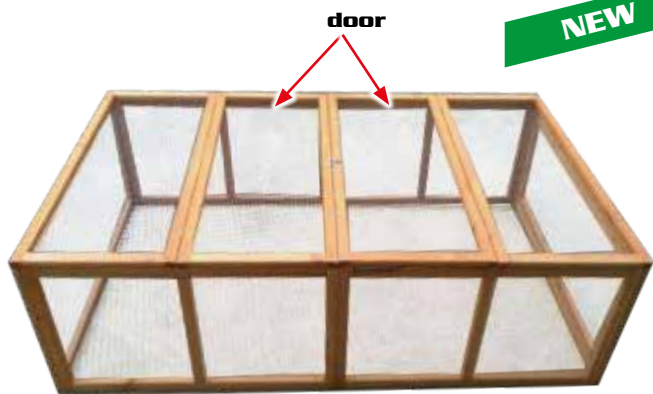

dimensions 104 x 50 x 104 cm

Made from durable fir wood

Without ground wires

Available
from 2/25

PROMINENT MIKE DOG HOUSE



dimensions 82 x 99 x 86 cm

Made from durable fir wood

Roof covered with asphalt shingle

Available
from 2/25

PROMINENT DINO DOG HOUSE



dimensions 112 x 75 x 79 cm

Made from durable fir wood

Openable asphalt roof with heat insulation,
raised floor with moisture-proof and ventilation

Available
from 2/25

PROMINENT PLASTIC DOOR DOOR FOR DOG HOUSES DINO AND MIKE



dimensions 38 x 52 cm

transparent PVC

Available
from 2/25

Speed and battery life depends on the terrain and the weight of the operator.

SUPER PREMIUM CAT TINS / PREMIUM CAT GRANULES

Prominent cat Chicken

Supplementary food for cats. Contains a high proportion of vitamins (A, E, D), minerals and amino acids in natural form. Does not contain chemicals, seasonings or preservative and coloring additives. Does not contain soya.



200 g 100 % meat and fresh products

Prominent cat Fish



200 g 100 % meat and fresh products

Prominent cat Beef



200 g 100 % meat and fresh products

Prominent cat Kitten

Complete extruded feed for kittens up to 12 months, pregnant and lactating cats



- 89 % animal proteins
- Fresh pork liver
- Salmon oil
- Yucca root

1,5 kg 22,5 % meat and fresh products

Prominent cat Adult Chicken

Complete feed for adult cats



- 88 % animal proteins
- Fresh liver
- Salmon oil
- Yucca root

1,5 kg 45 % meat and fresh products

Prominent cat Adult Salmon

Complete feed for adult cats



- 87 % animal proteins
- Fresh salmon
- Salmon oil
- Yucca root

1,5 kg 9 % meat and fresh products

Prominent cat Sterilized

Complete food for overweight adult cats, neutered and sterilized cats



- 86 % animal proteins
- Fresh liver
- Salmon oil
- Yucca root

1,5 kg 15 % meat and fresh products

www.hecht.cz

i Raw meat is added to the granules without any modifications. The granules therefore contain important nutrients, minerals and vitamins.

Traditional food for dogs and cats in premium quality produced in cooperation with proven feed manufacturers with many years of experience. Meat is added to the feed only in the raw state without further modifications. The granules therefore taste great and contain important nutrients, minerals and vitamins. Give your pets a quality and well balanced food. Product of the Czech republic.



TREATS FOR DOGS

Prominent Chicken Sandwich

Treats for dogs



80 g 40 % meat

Prominent Duck Sandwich

Treats for dogs



80 g 40 % meat

Prominent Beef Sticks

Treats for dogs



80 g 40 % meat

SUPER PREMIUM DOG TINS / PREMIUM DOG GRANULES

Prominent dog Chicken & Turkey

400 g 1270 g

Prominent dog Lamb & Rice

400 g 1270 g

Prominent dog Beef & Liver

400 g 1270 g

Prominent dog Venison

400 g 1270 g

Supplementary food for dogs. Contains a high proportion of vitamins (A, E, D), minerals and amino acids in natural form. Does not contain chemicals, seasonings or preservative and coloring additives. Does not contain soya.



100 % meat and fresh products



95 % meat and fresh products, 5 % rice



100 % meat and fresh products



100 % meat and fresh products

Prominent Dog biscuits

Supplementary food
for dogs



200 g

Prominent dog Puppy

Complete feed for puppies of all breeds, feed is also suitable for pregnant and lactating dogs



3 kg 10 kg

25 % meat and fresh products

Prominent dog Junior Large breeds

Complete feed for young dogs of large and giant breeds



3 kg 10 kg

22,5 % meat and fresh products

Prominent dog Adult MINI

Complete feed for adult dogs of small breeds



3 kg 10 kg

30 % meat and fresh products

Prominent dog Active

Complete feed for adult dogs of all breeds



12 kg

50 % meat and fresh products



GLUTEN FREE

Prominent dog Adult

Complete feed for adult dogs of all breeds



12 kg

20 % meat and fresh products

Prominent dog Adult Large breed

Complete feed for adult dogs of large and giant breeds



12 kg

20 % meat and fresh products

Prominent dog Sensitive

Hypoallergenic feed for adult dogs of all breeds



12 kg

15 % meat and fresh products

Prominent dog Senior

Complete feed for overweight adult dogs or older dogs



12 kg

20 % meat and fresh products

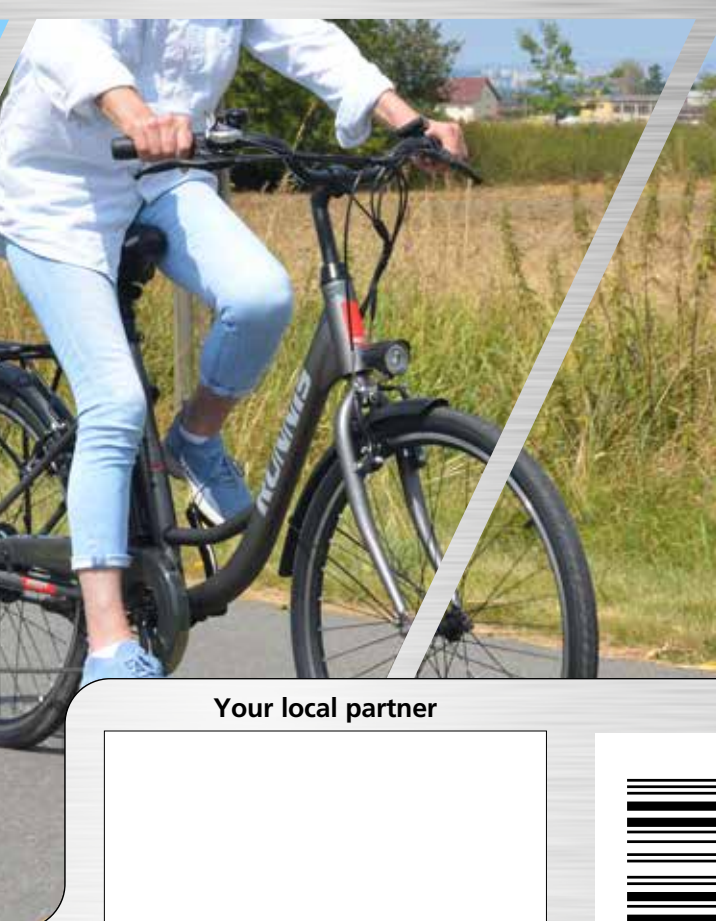

Your local partner

Descriptions, pictures and specifications may vary at time of shipping. Product images are for illustrative purposes only. Real product and accessories may vary.
Edition: January 2025

HECHT MOTORS s.r.o., U Mototechny 131, 251 62 Mukařov–Tehovec, Czech republic

www.hecht.cz

